

SHOULDER

Operative Technique



equinox[®]

Platform Shoulder System
with Ergo[®] Instruments

TABLE OF CONTENTS

PRIMARY SHOULDER

OPERATIVE TECHNIQUE OVERVIEW	4
DETAILED OPERATIVE TECHNIQUE	7
Preoperative Planning/Patient Positioning	7
Step 1: Patient Positioning	7
Step 2: Surgical Approach	7
Step 3: Humeral Preparation	8
Humeral Head Resection	8
Evaluate Resected Head Size.....	10
Reaming the Humeral Shaft	10
Broaching the Humeral Shaft.....	11
Planing	12
Humeral Stem Insertion.....	12
Humeral Protector	13
Step 4: Preparing the Glenoid	14
Glenoid Exposure.....	14
Assessing Glenoid Version	14
Choosing the Glenoid	14
Reaming the Glenoid	16
Preparing the Cemented Pegged and Cage Glenoid.....	20
Cementing the Cage Glenoid	21
Cementing the Pegged Glenoids	22
Removing the Cage Glenoid.....	23
Step 5: Head Positioning.....	24
Replicator Plate Selection.....	24
Attaching the Replicator Plate	24
Dialing in the Head Position	24
Assessing Range of Motion	26
Torque Defining Screw	27
Impacting the Humeral Head	28
Platform Stem Revision	29
Step 6: Closure.....	29
Revision and Closure	29

REVERSE SHOULDER

OPERATIVE TECHNIQUE OVERVIEW	31
DETAILED OPERATIVE TECHNIQUE	34
Step 1: Patient Positioning.....	34
Step 2: Surgical Approach	34
Deltpectoral Approach	34
Step 3: Humeral Preparation	35
Humeral Head Resection	35
Reaming the Humeral Shaft	37
Broaching the Humeral Shaft.....	38
Planing	39
Humeral Stem Protector	39
Step 4: Preparing The Glenoid.....	40
Glenoid Exposure.....	40
Reaming the Glenoid	40
Implanting the Glenoid Plate.....	45
Inserting the Glensphere Trial	48
Step 5: Trialing the Humeral Adapter Tray & Liner.....	50
Step 6: Inserting the Final Implants	52
Step 7: Deltpectoral Closure.....	56
Glensphere Removal	57
Humeral Liner Removal	57
IMPLANT LISTING	58
INSTRUMENT LISTING	60
SYSTEM SPECIFICATIONS.....	64
REFERENCES	68

SURGEON DESIGN TEAM:

Pierre-Henri Flurin, MD

Surgical Clinic of Bordeaux, Merignac (France)

Stephanie J. Muh, MD

Henry Ford Health System

Scott W. Trenhaile, MD

Orthollinois

Thomas W. Wright, MD

University of Florida

Joseph D. Zuckerman, MD

NYU Langone Orthopedic Hospital

OPERATIVE TECHNIQUE OVERVIEW

PRIMARY SHOULDER

PRIMARY SHOULDER



Figure A
Incision and Exposure



Figure B
Resect Humeral Head



Figure C
Ream Humeral Shaft



Figure D
Broach Humeral Shaft



Figure E
Insert Press-Fit Stem



Figure F
Place Humeral Stem Protector

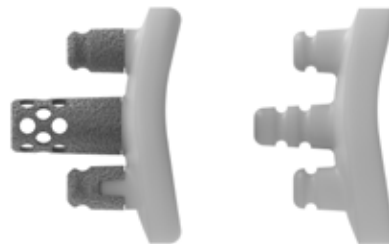

Figure G
Choose Glenoid



Figure H

Pilot Tip Option: Drill Center 3.2mm Pilot Hole, Ream the Glenoid and Drill Center Hole



Figure I

Cannulated Option: Insert 3.2mm K-wire, Ream and Drill Center Hole Over K-wire

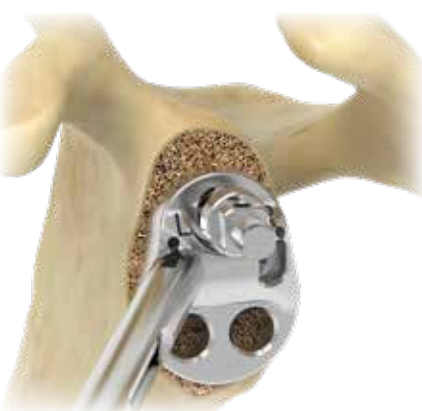

Figure J

Prepare Pegged Glenoid

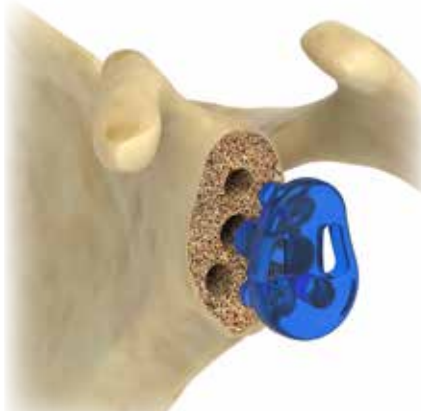

Figure K

Insert Trial Glenoid



Figure L

Pressurize Cement

OPERATIVE TECHNIQUE OVERVIEW

PRIMARY SHOULDER

PRIMARY SHOULDER



Figure M
Cement and Impact Final Glenoid



Figure N
Select and Attach Replicator Plate



Figure O
Cover Resected Surface with Dual Offsets



Figure P
Assess Range of Motion



Figure Q
Disengage Superior Portion of Torque Defining Screw



Figure R
Impact Final Humeral Head

PREOPERATIVE PLANNING/PATIENT POSITIONING

After a careful history and physical examination, radiographs should be obtained to assess glenohumeral joint space narrowing, osseous deformities and glenoid wear. The following three radiographic views should be obtained: 1) a true A/P view of the glenohumeral joint (30 degrees external oblique), 2) a scapular lateral view and 3) an axillary view.

In patients with osteoarthritis, varying amounts of posterior glenoid wear (with posterior subluxation of the humeral head) are common. If significant glenoid wear is a concern, a CT scan will be helpful to further define the bony anatomy.

Rotator cuff tears are relatively uncommon in patients with osteoarthritis. The status of the rotator cuff can be determined at the time of surgery. For this reason, MRI or ultrasonography imaging is not routinely performed, though the decision is based upon surgeon preference.

To aid in pre-operative planning, radiographic templates are available for the humeral stems, humeral heads and glenoids to approximate the required sizes. Additionally, the **Equinox Planning App** instantly creates the scapula in 3D so implants and positioning can be selected prior to surgery.

For humeral preparation using the Preserve or Stemless implants, reference these operative techniques: OPTECH-000154 and 718-10-31.

STEP 1: PATIENT POSITIONING

The patient should be placed on an operating table in a supine position. The head of the operating table should be elevated approximately 30 degrees in a modified beach chair position. A small bolster should be placed laterally behind the involved shoulder just medial to the scapular boarder. The patient should be moved to the side of the table so that the upper extremity can be placed into maximum extension without obstruction by the operating table. Alternatively, a Captain's chair or similar positioning device can be used for proper patient positioning. The patient should be secured to the operating table to minimize any changes in position intra-operatively.

Once the patient is secure, the extremity is examined to assess the range of motion, with particular attention to external rotation with the arm at the side. If external rotation is restricted (i.e., internal rotation contracture) the need for more extensive subscapularis mobilization or lengthening procedures may be necessary. The entire upper extremity should be prepped and draped to allow complete access to the operative area and full mobility during the procedure.

STEP 2: SURGICAL APPROACH

An anterior deltopectoral incision is made beginning inferior to the clavicle and passing over the coracoid process and extending distally toward the deltoid insertion. Medial and

lateral subcutaneous flaps are created, and the deltopectoral interval is identified.

A thin fat stripe is usually located over the cephalic vein. The interval is usually developed medial to the cephalic vein; the interval can also be developed laterally depending on the surgeon's preference. Branches of the cephalic vein on the approach side are cauterized, and the interval is developed inferior to superior to expose the clavipectoral fascia.

The advantage of retracting the cephalic vein with the deltoid is that the majority of the branches come from the deltoid. The disadvantage is the vein is more exposed to injury from the retractor as it crosses the superior aspect of the interval.

The subdeltoid space is mobilized with a blunt elevator. The clavipectoral fascia is incised longitudinally up to the coracoacromial ligament (which is spared), and the conjoined tendon is mobilized. A self-retaining retractor is placed with care to avoid excessive traction on the conjoined tendon. The coracoacromial ligament is identified and the subacromial space is mobilized with a blunt elevator. The subscapularis tendon insertion on the lesser tuberosity is identified along with the rotator interval. The anterior humeral circumflex vessels along the inferior border of the subscapularis muscle, the "three sisters," are cauterized extensively, and the biceps tendon is palpated in its groove. The subscapularis tendon and the capsule are tenotomized 1cm medial to the lesser tuberosity and tagged with #1 sutures.

An alternative approach is to elevate the subscapularis directly off of bone or elevate its insertion with a thin wafer of bone (1-2mm thick) using an osteotome. The choice is based primarily on surgeon preference.

The rotator interval is divided in a lateral to medial direction up to the superior glenoid rim. With the humerus extended, adducted and externally rotated, the capsule is carefully dissected off the inferior humeral neck, protecting the axillary nerve inferiorly with a small blunt retractor placed just inferior to the capsule. The capsular releases should be performed to allow 90 degrees of external rotation. The self-retaining retractor is then repositioned to retract the subscapularis. At this point, the humeral head can be dislocated.



DETAILED OPERATIVE TECHNIQUE

HUMERAL PREPARATION



Figure 1
Fixed Angle Cutting Guide

STEP 3: HUMERAL PREPARATION

Humeral Head Resection

Prior to the humeral head resection, all osteophytes should be removed using a rongeur. Doing so will properly expose the anatomic humeral neck; anatomic replication is facilitated by an accurate resection along the anatomic neck. Three resection options are available and should be selected based upon surgeon preference.

Note: Removing the osteophytes is imperative in order to visualize the anatomic neck.

Free Hand: Identify the anatomic neck and resect the head using a microsagittal saw.

Fixed Angle (132.5 degrees) Osteotomy Guide: Though this method is not based upon the patient's anatomy, we have provided a **Fixed Angle Cutting Guide** for surgeons who prefer this method (*Figure 1*). The surgeon may attach a version rod to the guide that will align the forearm at 0, 10, 20, 30, and 40 degrees of retroversion. Three options are available for the guide:

1) Use the cutting surface to make a free hand resection

2) Use the two 3.2mm Short Threaded K-wires to secure it to the bone or

3) Use the cutting surface to mark the resection line with a bovie and then use the free hand method.

With this method, the superior portion of the resection should be just medial to the rotator cuff insertion. The amount of retroversion (usually 20-40 degrees) should be determined by positioning the humerus in external rotation before the resection is made.

Note: The K-wire hole trajectory for both guides is straight / parallel with the cut. Avoid inserting pins off axis to prevent binding.

Note: After cutting with either guide (EM or IM) do not lever the short K-wires out of the bone.

Note: If the version rod blocks the saw, pin the guide in the preferred orientation, adjust the version rod position as needed, and finish the humeral head resection.



Figure 2
IM Guide and Pins

Intramedullary Humeral Cutting Guide

The Equinox **Intramedullary Humeral Cutting Guide** enables the surgeon to accurately resect the humeral head along the anatomic neck (*Figure 2*). Unlike other cutting guides, the Intramedullary Humeral Cutting Guide allows the surgeon to ream prior to the resection of the humeral head.

Note: *If the bone is too hard to insert the reamer by hand, use a mallet to lightly tap the reamer into the canal.*

Once the correct size reamer has been selected, attach the **IM Guide Boom** to the superior section of the reamer. After attaching the IM Guide Boom, slide the **IM Resection Guide** onto the distal tip of the boom until it locks in place.

When the cut guide has been appropriately placed at the correct height and retroversion has been achieved utilizing the **Retroversion Rod** (choosing between 0, 10, 20, 30 and 40 degrees), two short 3.2mm K-wires are used to immobilize the cut guide. Once the IM Resection Guide is securely pinned to the bone, remove the reamer and IM Guide Boom. After these are removed, make the humeral head cut and remove the cut guide and pins.

Note: *Removing the osteophytes is imperative in order to visualize the anatomic neck.*

Note: *The IM Resection Guide comes with a cut slot for retained resection, for sawblades up to 1.27mm in thickness. If a retained cut is not preferred, cutting above the IM Resection Guide is also available.*

DETAILED OPERATIVE TECHNIQUE

HUMERAL PREPARATION



Figure 3
Size Humeral Head

Head Size (mm)	38	41	44	47	50	53
	Black	Blue	Brown	Green	Orange	Purple
Glenoid Curvature	Alpha			Beta		

Table 1
Head Color and Relationship Between Humeral Head Diameter and Glenoid Curvature

Evaluate Resected Head Size

After resecting the humeral head, use a **Humeral Head Trial** to estimate both the head's diameter (circumferentially) and height in order to determine the probable size of the modular humeral head (*Figure 3*). **The head diameter will determine what glenoid curvature will be used, as detailed in Table 1.**

Reaming the Humeral Shaft

The smallest **Humeral Reamer** (7mm) has a sharp tip to facilitate the initial entry into the IM canal (*Figure 4*). The entry point is made just posterior to the bicipital groove and at the junction of the middle and upper thirds of the resected humeral surface. The canal should be sequentially reamed until endosteal cortical contact is obtained. It is imperative that the Reamer be inserted into the canal to the appropriate depth as indicated by the depth markers.

Note: The 7-13mm reamers have multiple depth markers; the first depth marker is for the standard stems, while any markers thereafter are for long stems.

Reaming prepares the canal for the distal diameter of the stem and determines the final diameter of the definitive stem. There is no need for forceful reaming. If there is difficulty fully inserting a reamer, the broach and implant selected should be the size of the last reamer that was completely seated. If there is any concern about the size of the implant to use, the smaller alternative should be selected since the stem can be cemented in place.

Note: To ensure the adequate depth is achieved, ream until the depth marker is no longer visible.



Figure 4
Insert Fluted Reamer



Figure 5a
Insert Broach



Figure 5b
Female Broach



Figure 5c
Broach Handle Collar Options

Note: Check the collar for migration after each impaction/extraction. Have an assistant cover the collar in case it becomes dislodged.

Note: Since the Reamer is the only instrument that prepares the distal canal, do not attempt to implant a stem that is larger than the largest fully seated reamer.

Broaching the Humeral Shaft

After the canal has been reamed, attach the smallest Broach (7mm) to the **Broach Handle** as illustrated (Figure 5a). The Broach should be inserted into the canal at a version consistent with that of the cut surface. The canal should be sequentially broached until the size of the broach matches that of the final reamer. Each Broach should be impacted until contact is made between the resected bone surface and the distal tip of the Handle or the bottom of the optional Broach Collar. Broaching can be performed with or without the collar (Figure 5c).

1) When using the collar, 0mm and 2mm options are available. If a flush impaction is desired, the 0mm is visible

as shown in Figure 5c. Alternatively, a 2mm option is used to countersink the broach.

2) The broach handle can also be used without the collar, if preferred.

As a visual check to assess version, the Retroversion Rod can be attached to the broach handle ("L" and "R" indicate appropriate side) and lined up with the patient's forearm (assuming the patient has a stable elbow). The retroversion rod can be inserted into the broach handle and will align with the forearm at 0, 10, 20, 30 and 40 degrees of retroversion.

Note: The **Stem Extraction Tool** is also an alternative option if the broach becomes countersunk too far (Figure 32).

Note: The Broach is securely locked to the Broach Handle when the trigger is returned to the starting position.

DETAILED OPERATIVE TECHNIQUE

HUMERAL PREPARATION



Figure 6
Plane Resected Humeral Head



Figure 7
Insert Humeral Stem

Planing

Planing of the resected humeral head surface is also available. Planing may be conducted off of both the broach, utilizing the **Calcar Planer Adapter - Female Broach**, or the final stem, through the final stem **Calcar Planer Adapter - Stem** (Figure 6).

Humeral Stem Insertion

One unique advantage of the Equinox primary shoulder system is that it does not require stem trialing. Once the humeral canal is prepared, the implant is ready to be inserted into the canal. The implant (**having the same distal diameter as that of the final reamer**) is threaded on to the **Stem Inserter** (Figure 7). Be sure to align the dimple on the Inserter with the divot in the stem.

Note: Only use finger tightening to assemble the Stem Inserter with the stem. The 3.5mm Hex Driver may be used to loosen the Stem Inserter after impaction. Excessive tightening can lead to device deformation causing instrument to bind with implant.

The broaches are undersized by 1mm (total diametrical press-fit 0.5mm per side) to ensure adequate press-fit; therefore, impaction is necessary to insert the stem into the canal. For this reason, it is important that the stem be completely threaded to the Stem Inserter prior to impaction to prevent damage to the threads. Use a mallet to impact the Stem Inserter until the superior face of the stem is at the level of the resected surface (only the strike surface should be used for impaction).

As a visual check to assess version, the Retroversion Rod can be attached to the Stem Inserter in the same manner described above.

Note: If a tendon-to-bone repair is utilized, prepare the drill holes in the proximal humerus to facilitate the subscapularis repair prior to humeral stem insertion.



Figure 8
Place Humeral Stem Protector

Cementing the Press-Fit Prosthesis

The press-fit Equinoxe humeral stem was designed with several features that optimize a cementless application. However, the stem has features that enable it to be cemented if desired. In this situation, a stem two sizes smaller in diameter (than the broach size) would provide a minimum 1mm cement mantle proximally and a minimum 2mm distally.

In cases where an adequate press-fit was not achieved, the surgeon has two options. A minimized cement technique could be employed whereby a small amount of cement is placed in the proximal canal and, for example, an 11mm stem is cemented in a humerus that has been reamed to an 11 and broached to an 11. Alternatively, in this same scenario, the surgeon could broach to a 13 to create room for a more robust proximal cement mantle and then cement the 11mm stem.

The use of a cement restrictor is based on personal preference; however, an appropriately sized cement restrictor will improve cement distribution. Formal cement pressurization is avoided to decrease the possibility of humeral shaft fracture. The intramedullary canal should then be packed with a sponge to obtain adequate drying before cementing. Once the canal is prepared, the cement is mixed and injected into the canal.

Humeral Protector

If the procedure requires a glenoid implant, place the correct sized **Humeral Protector** onto the proximal portion of the resected surface during glenoid preparation (*Figure 8*). The Humeral Protector can be connected to either the Humeral Broach or the Humeral Stem. If a glenoid is not being implanted, Step 4 is omitted.

Note: Avoid levering on the bone when removing the protector plates.

DETAILED OPERATIVE TECHNIQUE

PREPARING THE GLENOID

STEP 4: PREPARING THE GLENOID

Glenoid Exposure

Retractors are provided to aid in glenoid exposure. A posterior glenoid retractor should be used to displace the proximal humerus posteriorly (i.e. **Wolfe Retractor/Humeral Head Retractor, Dual Point Glenoid Retractor**). **Hohmann Retractors** are placed superiorly and inferiorly around the glenoid.

The glenoid labrum is excised and an anterior and inferior capsular release is performed both for exposure and soft tissue mobilization. A formal posterior capsular release is only performed if adequate glenoid exposure cannot be obtained or if limitation of internal rotation is identified as a significant problem.

Some surgeons prefer to resect the biceps insertion and perform a biceps tenodesis. Biceps release and tenodesis will also enhance glenoid exposure. At this point, the degree and location of glenoid erosion can be visualized.

Note: Some key steps to adequate glenoid exposure are as follows:

- 1) Fully mobilize subdeltoid space
- 2) Release inferior capsule completely off the humerus by externally rotating humerus
- 3) Release anterior capsule and subscapularis from glenoid
- 4) Excise labrum and release anterior and inferior capsule (protect axillary nerve)
- 5) Resect adequate amount of humerus
- 6) Retract the proximal humerus posteriorly with a posterior glenoid retractor. This will result in stretching of the posterior capsule which further facilitates glenoid exposure.
- 7) Biceps release with excision of superior labrum will also assist with glenoid exposure
- 8) If exposure is not adequate after steps 1-7, release posterior inferior capsule and triceps origin (must isolate and retract axillary nerve for this procedure)
- 9) If exposure is still poor (very rare), then a posterior capsule release should be performed.

Assessing Glenoid Version

Glenoid wear requires special consideration. With increasing posterior glenoid erosion, posterior humeral head subluxation occurs with secondary stretching of the posterior capsule. Options to treat this asymmetric wear include, most commonly, reaming eccentrically to lower the high (non-worn) side or using augmented glenoids to build up the worn side. See the **Posterior Augment Glenoid Operative Technique (718-01-32)** for additional information. In very severe cases, bone grafting to elevate the low (worn) side may also be another option. In Step 5, the surgeon will have the opportunity to modify humeral head version by up to 7.5 degrees if additional stability is required.

Pre-operative planning is also available, which allows surgeons to use a 3D rendering of the patients scapula to plan their case before surgery.

If the glenoid bone is inadequate (an uncommon occurrence), hemiarthroplasty should be performed with glenoid shaping to provide a concave surface for the humeral head.

Choosing the Glenoid

The Equinox System provides Caged, Pegged, and Posterior Augment Glenoid options (*Figure 9*). The specific glenoid chosen should be based on surgeon preference and the patient's anatomy. For severely eroded glenoids, refer to operative technique number 718-01-32 for use of the posterior augment glenoid. For the medium and large Pegged and Cage Glenoids, two articular curvatures are provided (alpha and beta) so that these sized glenoids can be matched with any size humeral head component (38mm - 53mm) while at the same time obtaining an optimal radial mismatch (average 5.5mm). This is accomplished by choosing an alpha or beta glenoid based upon the humeral head diameter. The small Pegged Glenoids are only provided in the alpha curvature (*Table 2*). The extra large Pegged Glenoid is only provided in the beta curvature.

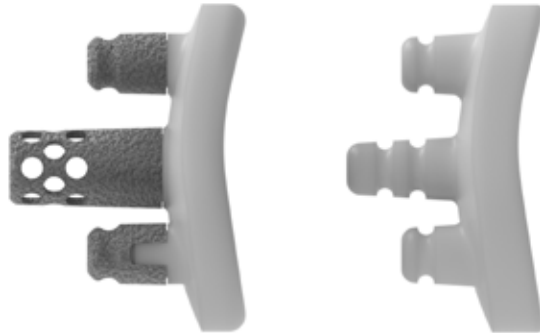

Figure 9
Equinoxe® Cage and Pegged Glenoids

	Humeral Head Diameter					
	38mm	41mm	44mm	47mm	50mm	53mm
Small, Medium and Large \varnothing UHMWPE Cage and Pegged Glenoids	✓	✓	✓			
Medium, Large and Extra Large \mathcal{S} UHMWPE Cage and Pegged Glenoids				✓	✓	✓

Table 2
Glenoid/Humeral Head Pairings

DETAILED OPERATIVE TECHNIQUE

PREPARING THE GLENOID



Figure 10a

Modular aTSA Reamer and Pilot Tip Driver



Figure 10b

Modular aTSA Reamer and Cannulated Glenoid Reamer Driver

Reaming the Glenoid

The Equinox primary system provides two options to ream the glenoid: 1) **Pilot Tip Glenoid Reaming** and 2) **Cannulated Glenoid Reaming** (Figures 10a and 10b). Pilot Tip Reaming technique has a rounded-pilot tip driver, which provides the surgeon greater angular adjustability and thereby facilitates eccentric reaming. Cannulated reamers rotate about a 3.2mm K-wire and provide the surgeon with more control. The **Modular Anatomic Reamer** attaches to either the **Pilot Tip Glenoid Reamer Driver** or the **Cannulated Glenoid Reamer Driver** by pulling back the black sleeve on the driver and inserting the appropriate reamer onto the driver.

Note: Verify that the reamer is attached to the Reamer Driver before reaming.

Note: Avoid applying a bending force to the Reamer Driver (e.g. using the Reamer Driver to assist with exposure). This could lead to fracture of the pilot tip or 3.2mm K-wire.

Regardless of the reaming option, the first step is to identify the center of the glenoid (the point where the superior/inferior and anterior/posterior glenoid axes intersect); ensure that all glenoid osteophytes have been removed so that the true center of the glenoid can be accurately identified. **Glenoid Sizers** (small, medium, large, and extra large) are provided that correspond to the various size glenoid implants and can assist with choosing a size that best matches the articular surface of the glenoid.

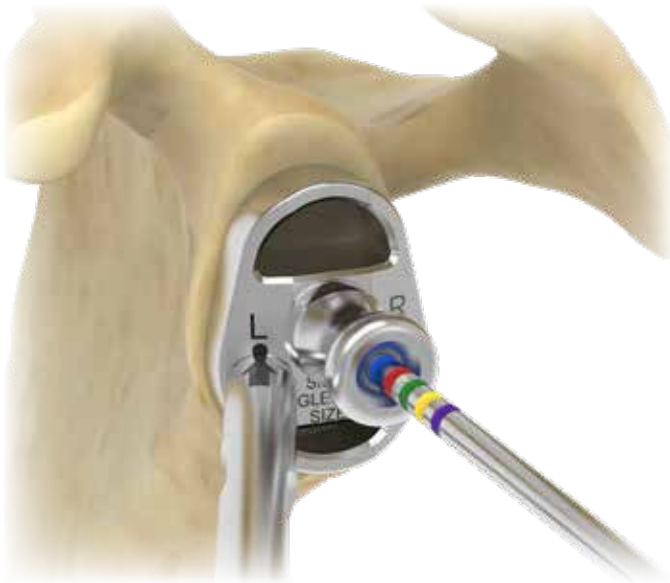

Figure 11
Drill 3.2mm Pilot Hole



Figure 12
Ream the Glenoid

Choose the appropriate glenoid sizer and attach this to the **Modular Glenoid Guide Handle** by **matching the laser marking on both the Glenoid Sizer and Handle** (Figure 11). The same guide will be used for both left and right shoulders, as indicated by the L and R laser marks.

If using the Pilot Tip procedure, start by drilling a 3.2mm hole using the 3.2mm drill bit, **K-wire Adapter** and selected glenoid sizer (Figure 11). It is suggested that the surgeon drill to at least the **blue** (30mm) **depth marking** when making the pilot tip hole.

An **Extra Small Modular aTSA Reamer** is provided to aid the surgeon in the initial preparation. Connect the appropriately sized Reamer to the PilotTip Glenoid Reamer

Driver. Sequentially ream the glenoid to the appropriate size (Figure 12). If substantial posterior glenoid erosion is evident, augmented components are available to restore version and ensure the implant is fully supported.

Note: Verify that the handle mechanism is locked on the sizer prior to inserting into the wound.

Note: Check that the reamer or drill is engaged on the driver handle before starting.

Note: Start the reamer prior to engaging bone.

DETAILED OPERATIVE TECHNIQUE

PREPARING THE GLENOID

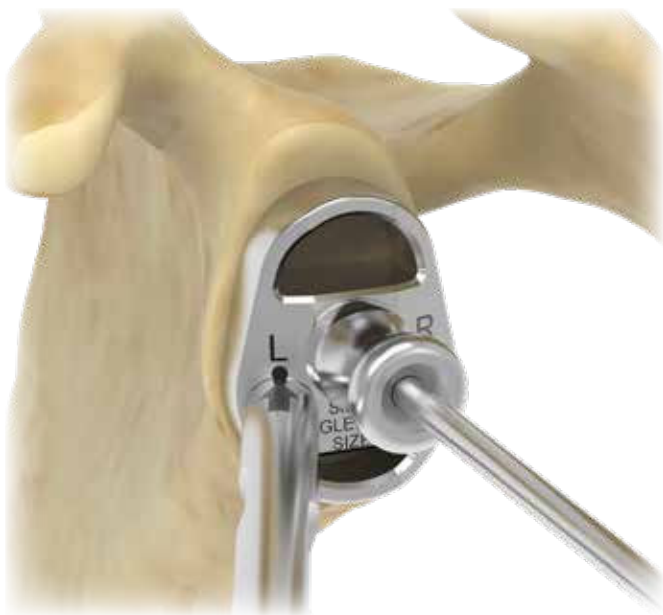

Figure 13
Insert 3.2mm Steinmann Pin



Figure 14
Ream the Glenoid

If using the Cannulated Reaming Technique, insert the **3.2mm Threaded K-wire** through the Sizer and K-wire Adapter and carefully drill under power until the Steinmann pin has engaged the medial cortex of the glenoid vault (*Figure 13*).

Once the K-wire is securely placed, back the guide out over the pin and remove from the joint (*Figure 13*).

Connect the appropriately sized Reamer (note that the reamers are labeled on the back) to the Cannulated Glenoid Reamer Driver. Sequentially ream the glenoid over the central K-wire to the appropriate size (*Figure 14*).

Note: Avoid applying a bending force to the 3.2mm K-wire as this may cause fracture.



Figure 15
Drill the Center Hole

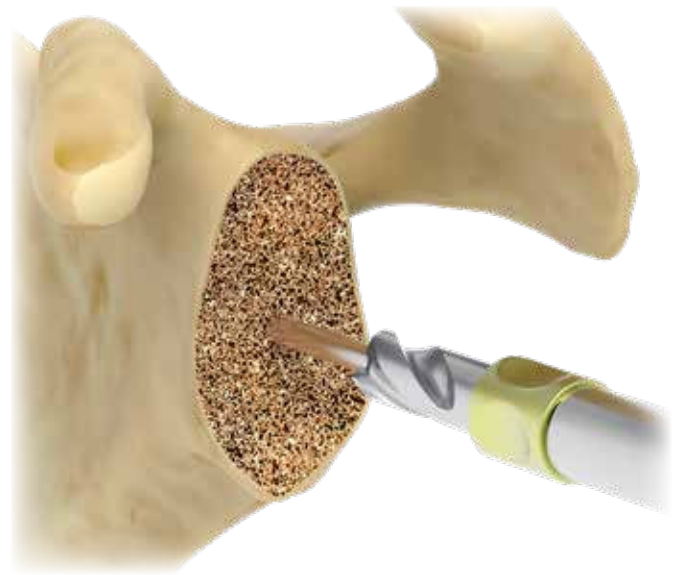

Figure 16
Drill Center Hole Over 3.2mm Steinmann Pin

After reaming, if using the Pilot Tip method, connect the Modular Center Peg Drill to the Cannulated Glenoid Reamer Driver and drill center hole through the appropriate Glenoid Sizer (Figure 15).

If using the Cannulated Technique, connect the **Modular Cannulated Center Peg Drill** to the Cannulated Glenoid Reamer Driver and drill the center hole over the 3.2mm K-wire. Drill until the collar of the drill bit contacts the glenoid surface and is fully seated. Do not drill through Modular Center Peg Guide if using Cannulated Technique (Figure 16).

WARNING: Avoid applying a bending force to the 3.2mm Steinmann Pin as this may cause fracture. Driver and drill bits should be removed by pulling straight back over the wire to prevent unnecessary bending.

DETAILED OPERATIVE TECHNIQUE

PREPARING THE GLENOID

Size	Glenoid Peg Trial Color
S	Blue
M	Green
L	Purple
XL	Yellow

Table 3
Glenoid Size Color Coded Trials

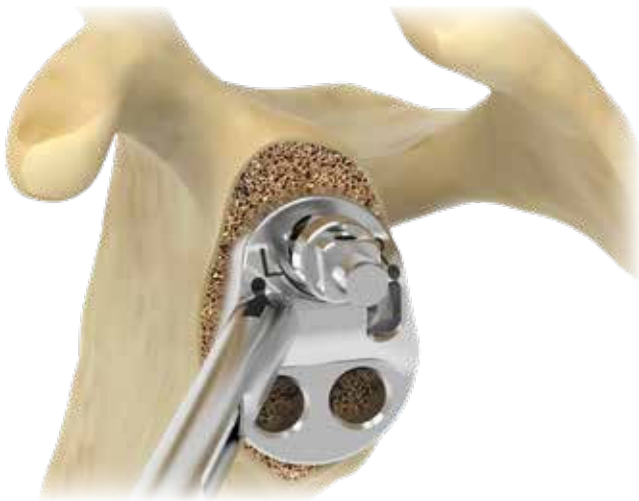

Figure 17
Drill the Peripheral Holes

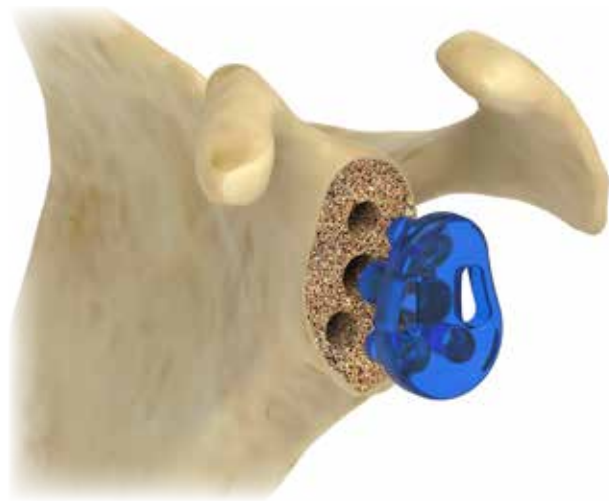

Figure 18
Insert Glenoid Trial

Preparing the Cemented Pegged and Cage Glenoid

Connect the **Modular Peripheral Peg Drill** to the Peripheral Peg Driver and drill the three peripheral holes through the **Peripheral Peg Drill Guide** (Figure 17). Connect the Modular Glenoid Guide Handle to the Peripheral Peg Drill Guide using the same method as attaching the Glenoid Sizers.

Note: Avoid levering on the Peripheral Peg Drill guide after drilling.

When drilling the peripheral peg holes, the Modular Peripheral Peg Drill will release and act as the holding pin for the Peripheral Hole Drill Guide, as needed. After drilling the peripheral holes, and removing the Drills and Drill Guide, use

the **Glenoid Peg Trial** to ensure correct coverage as well as to check that the holes were prepared to the defined depth (Figure 18). If the Pegged Glenoid Trial is not fully seated, re-drill holes as needed.

Note: Pegged Glenoid Trials were designed to fit conveniently in Allis clamps or forceps for easy insertion/removal.

Since the peg pattern/spacing is the same on all sizes, the surgeon may easily upsize or downsize the Pegged Glenoid to achieve the best coverage (provided that all the cortical bone was reamed).

Note: Trials are color coded (Table 3).



Figure 19
Cage Glenoid

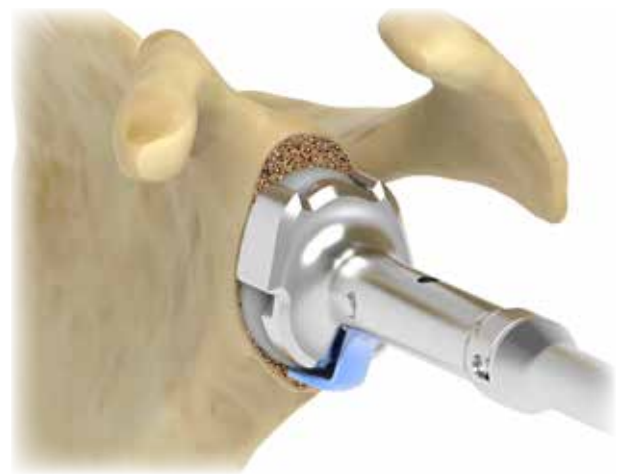

Figure 20
Impact Cage Glenoid Component Using the
Appropriately Sized aTSA Glenoid Impactor

Cementing the Cage Glenoid

Prepare the glenoid by first copiously irrigating the holes to clear any debris. Cement should be placed in each of the peripheral drilled peg holes. After placing cement, the **Cement Pressurizer Peripheral Pegs** should be used to pressurize the cement in the glenoid (*Figure 21*).

Note: When inserting the final implant, keep the inserter pointed up with a hand underneath until the implant is in the wound.

A second injection of cement with thumb pressurization is then completed. The glenoid component is then seated using the correct size **aTSA Glenoid Impactor** (*Figure 20*). Each Impactor is color coded to match their corresponding glenoid trial. Ensure the **Glenoid Impactor Tip** is fully assembled to the **Impactor Handle** before striking.

WARNING: Don't assemble or disassemble devices in the surgical field.

Note: Ensure straight line visibility for cage insertion.

DETAILED OPERATIVE TECHNIQUE

PREPARING THE GLENOID

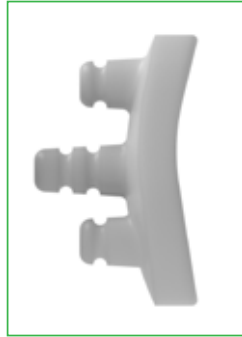

Figure 21
Pressurize the Cement



Figure 22
Impact with Glenoid Impactor Tip

Strike the Glenoid Impactor with a mallet to ensure that the glenoid component is in complete contact with the bone. Apply firm, steady digital pressure on the glenoid until polymerization is complete. Run a small elevator around the edge of the glenoid component to ensure there is no interposed soft tissue. Excess cement around the edges of the glenoid implant is removed before the cement polymerizes.

Cementing the Pegged Glenoids

Prepare the glenoid by first copiously irrigating the holes to clear any debris. Place thrombin-soaked surgigel, or a similar hemostatic agent, in the prepared peg holes. A **Cement Pressurizer Central Peg** and **Cement Pressurizer Peripheral Pegs** are provided and can be attached to the Modular Impactor Handle (*Figure 21*).

A second injection of cement with thumb pressurization is then completed. The glenoid component is then seated using the Glenoid Impactor. Ensure the **Glenoid Impactor Tip** is fully connected to the Impactor before striking (*Figure 22*).

WARNING: Don't assemble or disassemble devices in the surgical field.

Strike the Glenoid Impactor with a mallet to ensure that the glenoid component is in complete contact with the bone. Apply firm, steady digital pressure on the glenoid until polymerization is complete. Run a small elevator around the edge of the glenoid component to ensure there is no interposed soft tissue. Excess cement around the edges of the glenoid implant is removed before the cement polymerizes.

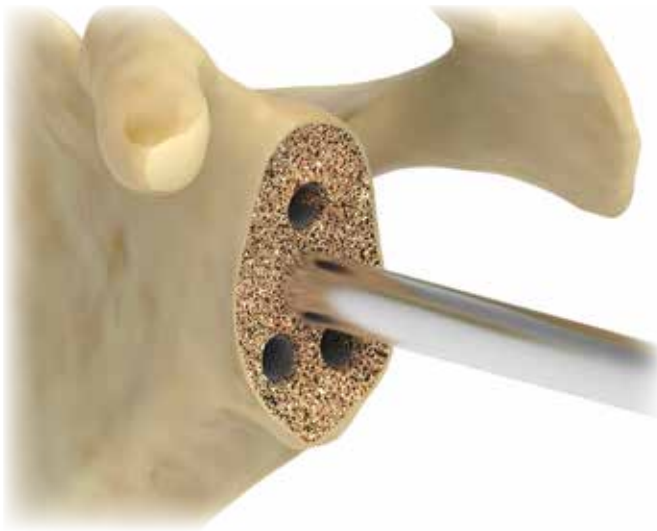

Figure 23a

Thread Center Peg Extractor to Internal Thread of Cage Peg

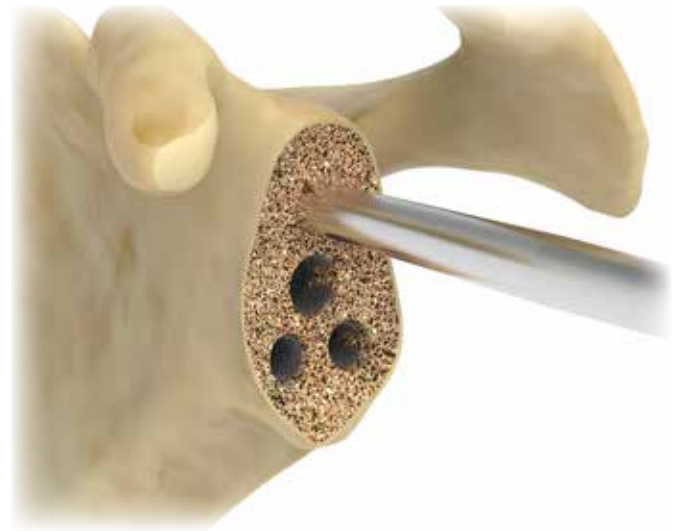

Figure 23b

Axially Remove Each Peripheral Peg

Removing the Cage Glenoid

Should the implant need to be removed after implantation for any reason, a thin flat osteotome should be used between the glenoid backside curvature and the glenoid bone – doing so should disengage the UHMWPE (Polyethylene) articular surface from the metal pegs. Each metal peg has an internal female thread to facilitate removal of each individually. The **Central Peg Extractor** is threaded into the thread of the cage peg (*Figure 23a*) and then connected to a Slap Hammer

to axially disengage. Similarly, the **Peripheral Peg Extractor** is threaded into each Peripheral Peg (*Figure 23b*) and then connected to a Slap Hammer to axially disengage.

Note: Once the Central Peg Extractor is threaded into the Central Peg, twist 90 degrees to break off any bone that is still attached to the Central Peg.

DETAILED OPERATIVE TECHNIQUE

HEAD POSITIONING

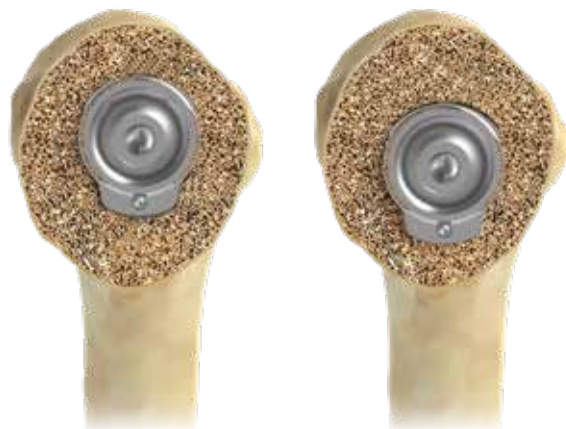

Figure 24
Replicator Plate Options



Figure 25
Replicator Plate Assembly

STEP 5: HEAD POSITIONING

Replicator Plate Selection

Remove the Humeral Protector and assess the position of the stem's spherical bore in relation to the resected surface of the proximal humerus. In the majority of cases, the stem will be offset from the center of the resected surface (in any direction) by more than 3mm. In this situation, a **4.5mm Replicator Plate** should be used. If this is not the case a **1.5mm Replicator Plate** should be used (Figure 24).

Attaching the Replicator Plate

Attach the Replicator Plate to the stem by hand tightening the Torque Defining Screw with the **Torque Defining Screw Removal Instrument** (Figure 25). Once the Torque Defining Screw meets resistance, loosen it one turn (this will provide adjustability to the Replicator Plate so the desired head position can be obtained).

Note: Avoid using the rTSA screw Starter Tool to start the aTSA torque Defining Screw.

Dialing in the Head Position

Place the appropriately sized **Plate Dial** (diameter matches the options for head implant diameters) on the Replicator Plate and insert the **Replicator Alignment Handle** (Figure 26) into the two holes on the Replicator Plate. The Replicator Plate Handle should be connected to the Non-ratcheting Screw Driver Handle.

Note: The Replicator Alignment Handle has the ability to change handle positions as needed using the push button at the top of the instrument.



Figure 26
Dialing in the Head Position



Figure 27
Dual Eccentricities

The surgeon now has the ability to adjust four independent variables to ensure the prosthesis reproduces the patient’s original anatomy: medial offset, posterior offset, inclination and version. When the head resection matches the anatomical neck, the surgeon can replicate the patient’s anatomy by simply covering the resected humeral surface.

Note: Both the Replicator Plate and the Plate Dial rotate independently to provide dual eccentricities.

The Equinox System provides eccentricity on two components: in the Humeral Head and in the Replicator Plate (Figure 27). These two eccentricities enable the surgeon to reproduce both the medial and posterior offset independently by turning the plate dial and the replicator plate separately.

If the surgeon desires to compensate for a less than perfect humeral resection, the system provides +/- 7.5 degrees to adjust the neck angle (inclination) and the version for a total range of 15 degrees for each parameter.

If the surgeon is pleased with the humeral head resection, begin the trialing process with the Plate Dial parallel to the resection (i.e., neck angle and retroversion match the cut). Cover the resected surface by rotating the Plate Dial with your fingers and the Replicator Plate. Angulation (neck angle and retroversion) adjustments should be assessed during the trial reduction (i.e., if posteriorly unstable, consider reducing the retroversion by loosening the screw and tilting the Replicator Plate).

DETAILED OPERATIVE TECHNIQUE

HEAD POSITIONING



Figure 28
Humeral Head Trial

		Head Diameter (mm)					
		38	41	44	47	50	53
Height	Short	16	16	17	18	19	20
	Tall	19	20	21	22	23	24

Table 4
Humeral Head Scope

Once the Plate Dial is perfectly positioned, tighten the Torque Defining Screw. (This is an interim tightening. The screw is not completely torqued until after assessing the range of motion.) Using the numbers on the Plate Dial, take note of the head position or make an identifying mark in order to place the **Head Trial** on the Replicator Plate with the exact same orientation (*Figure 28*). Replace the Plate Dial with the same size Head Trial (color-coded) and assess the range of motion as described below.

Assessing Range of Motion

Assessment of stability is performed in a step-wise sequence. First, the articulation is assessed with the arm at the side. The arm is rotated internally and externally; rotation should be smooth, and the humeral head should maintain a reduced position on the glenoid component. Second, with the arm at the side, anterior, posterior and inferior translation

should be assessed. Up to 50 percent posterior and inferior translation is acceptable; up to 25 percent anterior translation is acceptable. Third, range of motion is assessed. The arm should internally rotate to the chest wall without limitation. At 90 degrees of abduction, the shoulder should internally rotate 70 degrees.

Varying the thickness of the modular Humeral Head provides the ability to optimize stability and range of motion (*Table 4*). If soft-tissue laxity is excessive, a taller Humeral Head may be necessary. Conversely, if soft-tissue tension is excessive, a shorter Humeral Head may be necessary. **In general, the thinnest Humeral Head that provides adequate stability should be used to avoid overstuffing the joint.** If the surgeon desires to further adjust the positioning of the head, simply loosen the screw one-half rotation and repeat the previous steps.

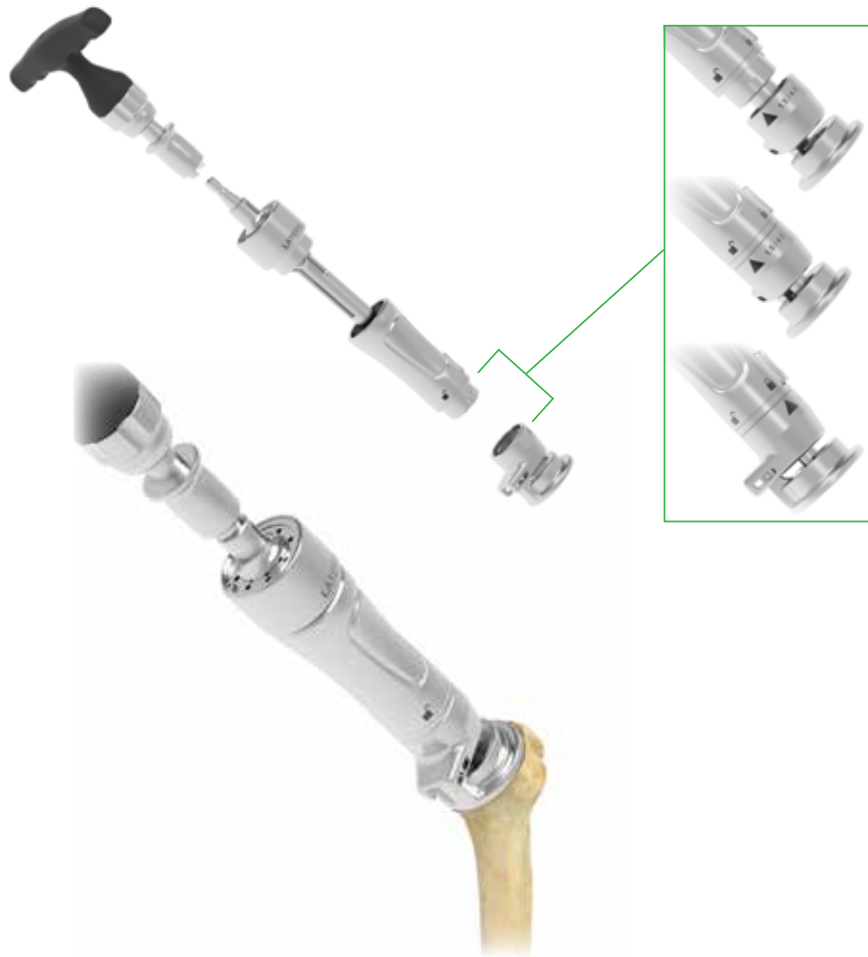

Figure 29
Disengage the Superior Portion of the Screw

Torque Defining Screw

Once the surgeon is satisfied with the position of the Replicator Plate and the size of the trial Humeral Head, remove the Head Trial.

Choose the appropriate counter torque tip based on the type of replicator plate being used. The **Anatomic Counter Torque 1.5/4.5 Offset Tip** should be attached if a 4.5mm or 1.5mm replicator plate is being used, and the **Anatomic Counter Torque 0 Offset Tip** should be attached if a 0mm replicator plate is being used. Attach the appropriate tip to the **Modular Counter Torque Handle** and insert the **Anatomic Counter Torque Handle** over the replicator plate by aligning it to fit within the two holes of the replicator plate. Slide the **Geared Torque Screw Driver** into the **Counter Torque Handle** until it is engaged with the superior portion of the Torque Defining Screw. Attach the Ratcheting T-handle and the plate is now

ready to be locked into position. Hold the Counter Torque Handle with one hand while tightening the screw until the superior portion disengages, which will occur at an applied torque of 11 N·m.

After the superior portion of the Torque Defining Screw disengages, verify that the piece is retained by the Geared Torque Screw Driver.

Note: The superior portion of the Torque Defining Screw must be removed before sterilization by inserting a 3.2mm K-wire through the top of the Geared Torque Screw Driver.

Note: Always remove the Geared Torque Screw Driver first, then remove the Modular Counter Torque Handle.

Note: Do not leave the Geared Torque Screw Driver of the Modular Counter Torque Handle unsupported in the wound.

DETAILED OPERATIVE TECHNIQUE

HEAD POSITIONING



Figure 30
Impact the Humeral Head

Impacting the Humeral Head

Clean and dry the visible portion of the Replicator Plate and place the final Humeral Head implant on the Replicator Plate using the numbers on the bottom of the implant to replicate the Head Trial orientation. Ensure the **Humeral Head Impactor Tip** is fully attached to the Impactor Handle before striking. Hand-test to ensure proper seating. Using the Humeral Head Impactor Tip and a mallet, strike the head directly in line with the taper to ensure proper engagement of the morse taper (*Figure 30*).

WARNING: Don't assemble or disassemble devices in the surgical field.



Figure 31
Head Removal Tool



Figure 32
Stem Extractor Tool

Platform Stem Revision

Gaining exposure to the glenoid after a hemiarthroplasty, while rarely easy, is facilitated with the Equinoxe System’s removable Replicator Plate. Using the **Head Removal Tool**, lever the head off the Replicator Plate (*Figure 31*).

When the Torque Defining Screw was initially torqued, the portion that snapped off left a square that can be used to remove the screw. Attach the Torque Defining Screw Removal Instrument to the **Ratcheting T-handle** and loosen the screw while also using the **Replicator Alignment Handle** handle to prevent the stem from twisting.

The Replicator Plate can now be removed and discarded. Protect the resected humeral surface and humeral stem with the Humeral Stem Protector while the glenoid is prepared. A new Replicator Plate, screw and head should be used to ensure proper engagement of the Morse taper.

If the stem must be removed, attach the **Stem Extraction Tool**

as well as a slap hammer to remove the stem (*Figure 32*). This method can also be used to remove the broach if needed.

Note: Verify that the threaded portion of the slap hammer is fully engaged before actuating.

STEP 6: CLOSURE

Closure is performed beginning with the subscapularis. The repair of the subscapularis will depend on the type of exposure used: tenotomy, elevation off bone or elevation with a wafer of bone. In general, #2 non-absorbable braided suture, or its equivalent, is used for either a tendon-to-tendon, tendon-to-bone or bone-to-bone repair. The rotator interval is then closed, though it may be left partially open medially to avoid excessive tension of the closure. External rotation is checked at this point to define the parameters for post-operative rehabilitation. A drain may be used, placing it deep into the deltopectoral interval. The deltopectoral interval is closed followed by closure of the subcutaneous tissue and the skin. The upper extremity is then placed in a sling and swathe.

REVERSE SHOULDER





Figure A
Resect the Humeral Head



Figure B
Ream Humeral Shaft



Figure C
Broach Humeral Shaft



Figure D
Place Humeral Stem Protector

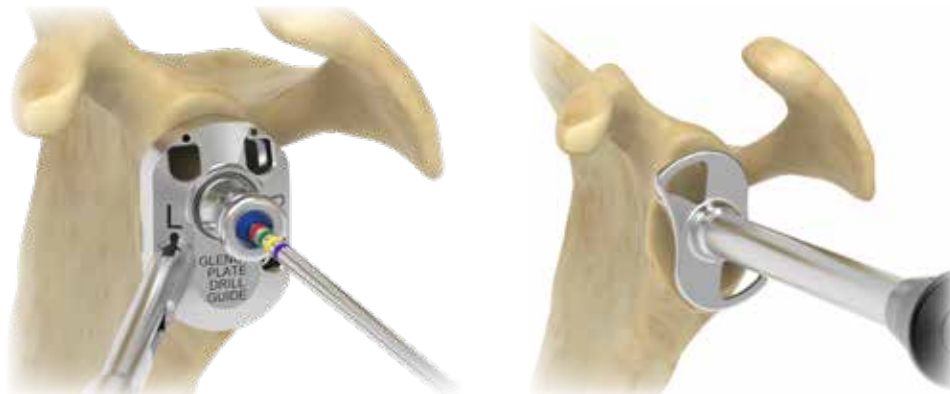

Figure E
Pilot Tip Option: Drill Pilot Hole, Ream the Glenoid
and Drill Glenoid Plate Hole

OPERATIVE TECHNIQUE OVERVIEW

REVERSE SHOULDER

REVERSE SHOULDER

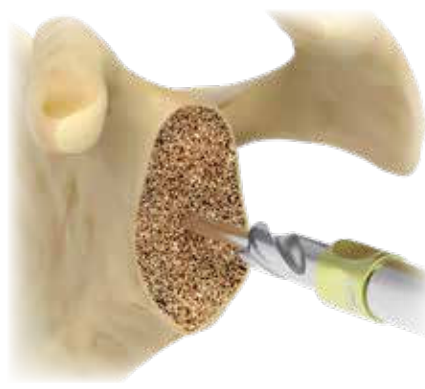

Figure F
Cannulated Option: Insert K-wire, Ream the Glenoid and Drill Glenoid Plate Hole over K-wire

Figure G
Insert Glenoid Plate



Figure H
Drill and Implant Compression Screws

Figure I
Insert and Tighten Locking Caps

PILOT-TIP GLENOSPHERE
INSERTER

KLIMO GLENOSPHERE
INSERTER

DOLPHIN GLENOSPHERE
INSERTER

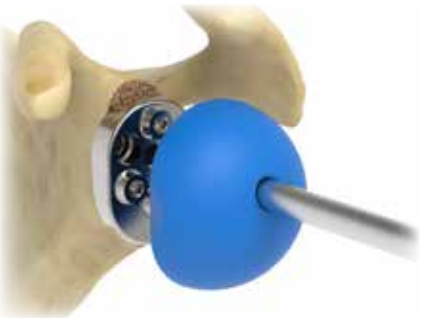

Figure J
Insert Glenosphere Trial



Figure K
Insert Humeral Tray Trial and
Humeral Liner Trial



Figure L
Insert Definitive Glenosphere
and Screw



Figure M
Insert Definitive Stem



OR



Figure N
Implant Definitive Tray



OR



Figure O
Implant Definitive Liner

DETAILED OPERATIVE TECHNIQUE

REVERSE SHOULDER

After a careful history and physical examination, radiographs should be obtained to assess glenohumeral joint space narrowing, osseous deformities and glenoid wear. A CT scan is helpful to assist in the evaluation of the quality of bone stock and to further evaluate bone deformities that may be present. An MRI may be obtained if further evaluation of the soft tissues is determined to be helpful. To aid in pre-operative planning, radiographic templates are provided for the humeral components and glenoid components to approximate the required size and alignment of the implants.

STEP 1: PATIENT POSITIONING

The patient should be placed on an operating table in a supine position. The head of the operating table should be elevated approximately 30-40 degrees in a modified beach chair position. A small bolster should be placed laterally behind the involved shoulder. The patient should be moved to the side of the table so that the upper extremity can be placed in maximum extension without obstruction by the operating table. Alternatively, a Captain's chair or similar positioning device can be used for proper patient positioning. The patient should be secured to the operating table to minimize any changes in position intra-operatively. The entire upper extremity should be prepped and draped to allow complete access to the operative area and full mobility during the procedure. Either a deltopectoral or a superolateral approach may be used depending on the surgeon's preference and clinical parameters. Additionally, the **Equinox Planning App** instantly creates the scapula in 3D so implants and positioning can be selected and positioned prior to surgery.

STEP 2: SURGICAL APPROACH

Deltopectoral Approach

An anterior deltopectoral incision is made beginning inferior to the lateral clavicle, passing over the coracoid process and extending distally toward the deltoid insertion. Medial and lateral subcutaneous flaps are created, and the deltopectoral interval is identified.

A thin fat stripe is often located over the cephalic vein. The interval is usually developed medial to the cephalic vein; the interval can also be developed laterally depending on the surgeon's preference. Branches of the cephalic vein on the approach side are cauterized, and the interval is developed inferior to superior to expose the clavipectoral fascia.

The advantage of retracting the cephalic vein with the deltoid is that the majority of the branches enter from the deltoid. The disadvantage is the vein is more exposed to injury from the retractor as it crosses the superior aspect of the interval. The subdeltoid space is mobilized with a blunt elevator. The clavipectoral fascia is incised longitudinally up to the coracoacromial ligament (which is spared), and the conjoined tendon is mobilized. A self-retaining retractor is

placed with care to avoid excessive traction on the conjoined tendon. The coracoacromial ligament is identified and the subacromial space is mobilized with a blunt elevator. The subscapularis tendon insertion (if present) on the lesser tuberosity is identified along with the rotator interval.

The anterior humeral circumflex vessels along the inferior border of the subscapularis muscle (the "three sisters") are cauterized extensively. The axillary nerve should be palpated in its position at the inferomedial border of the subscapularis. Exposure of the nerve for direct visualization can be performed at this point based upon surgeon preference. The biceps tendon (if present) is palpated in its groove. A biceps tenodesis can be performed at this point by dividing the tendon in the mid-portion of the groove and securing it either to the adjacent soft tissues or to bone based upon surgeon preference. The subscapularis tendon and the capsule are tenotomized 1cm medial to the lesser tuberosity and tagged with #1 sutures. The inferior capsule should be released from the humeral neck to allow the humerus to be externally rotated 90 degrees. As this release is performed, the axillary nerve should be protected by placing a blunt elevator between it and the inferior capsule.

An alternative approach is to elevate the subscapularis directly off the bone or elevate its insertion with a thin wafer of bone (1-2mm thick) using an osteotome. The choice of subscapularis detachment and subsequent reattachment is based primarily on surgeon preference. In some cases, particularly with revision surgery, the subscapularis may be absent or only the inferior portion may remain.

Exposure of the subacromial space will reveal a massive rotator cuff defect. Often there is an extensive amount of fibrous and bursal tissue filling this area that should be excised. The humerus can then be placed in extension, adduction and external rotation to begin preparation of the humerus. The large deltoid retractor should be used to enhance exposure of the proximal humerus.



Figure 33
Humerus

The humerus should be placed in extension, adduction and external rotation along with superior displacement to dislocate the humeral head anterosuperiorly for exposure. Once again, the large Deltoid Retractor can be used to enhance visualization and exposure of the proximal humerus.

STEP 3: HUMERAL PREPARATION

Humeral Head Resection

Prior to humeral head resection, all osteophytes should be removed using a Rongeur (*Figure 33*). Doing so will properly allow identification and exposure of the anatomic humeral neck. An aggressive resection at, or just distal to, the anatomic neck is recommended.

Note: Removing the osteophytes is suggested in order to visualize the anatomic neck.

Note: The K-wire hole trajectory for both guides is straight / parallel with the cut. Avoid inserting pins off axis to prevent binding.

Note: After cutting with either guide (EM or IM) do not lever the short K-wires out of the bone.

Note: If the version rod blocks the saw, pin the guide in the preferred orientation, adjust the version rod position as needed, and finish the humeral head resection.

Free Hand: The anatomic neck is identified and the head is resected using a microsagittal saw at, or just distal to, the anatomic neck.

DETAILED OPERATIVE TECHNIQUE

HUMERAL PREPARATION



Figure 34
Fixed Angle Cutting Guide



Figure 35
IM Guide and Pins

Fixed Angle (132.5 degrees) Osteotomy Guide: Though this method is not based upon the patient's anatomy, we have provided a **Fixed Angle Cutting Guide** for surgeons who prefer this method (*Figure 34*). The surgeon may attach a version rod to the guide that will align the forearm at 0, 10, 20, 30, and 40 degrees of retroversion. Three options are available for the guide:

- 1) Use the cutting surface to make a free hand resection
- 2) Use the two **3.2mm Short Threaded K-wire** to secure it to the bone or
- 3) Use the cutting surface to mark the resection line with a bovie and then use the free hand method.

The Equinox **Intramedullary (IM) Resection Guide**, connected to the **Intramedullary (IM) Guide Boom**, enables the surgeon to accurately resect the humeral head along the anatomic neck (*Figure 35*). Unlike other cutting guides, the IM Resection Guide allows the surgeon to ream prior to the resection of the humeral head.

Note: If the bone is too hard to insert the reamer by hand, use a mallet to lightly tap the reamer into the canal.

Once the correct size reamer has been selected, attach the IM Guide Boom to the superior section of the reamer. After attaching the IM Guide Boom, slide the IM Resection Guide onto the distal tip of the boom until it locks in place.



Figure 36
Insert Reamer

When the cut guide has been appropriately placed at the correct height and retroversion (choosing between 0, 10, 20, 30 and 40 degrees), two short 3.2mm K-wires are used to immobilize the cut guide. Once the cut guide is securely pinned to the bone, remove the reamer and IM Resection Guide. After these are removed, make the humeral head cut and remove the cut guide and pins.

Note: The IM Resection Guide comes with a cut slot for retained resection for sawblades up to 1.27mm in thickness. If a retained cut is not preferred, cutting above the IM Resection Guide is also available.

Reaming the Humeral Shaft

The smallest Reamer (7mm) has a sharp tip to facilitate the initial entry into the IM canal (Figure 36). The entry point is made just posterior to the bicipital groove and at the junction of the middle and upper thirds of the resected humeral surface. The canal should be sequentially reamed until

endosteal cortical contact is obtained. It is imperative that the Reamer be inserted into the canal to the appropriate depth as indicated by the depth markers.

Note: The 7-13mm reamers have multiple depth markers; the first depth marker is for the standard stems, while any markers thereafter are for long stems.

Reaming prepares the canal for the distal diameter of the stem and determines the final diameter of the definitive stem. There is no need for forceful reaming. If there is difficulty fully inserting a reamer, the broach and implant selected should be the size of the last reamer that was completely seated. If there is any concern about the size of the implant to use, the smaller alternative should be selected since the stem will be cemented in place.

Note: To ensure the adequate depth is achieved, ream until the depth marker is no longer visible.

DETAILED OPERATIVE TECHNIQUE

HUMERAL PREPARATION

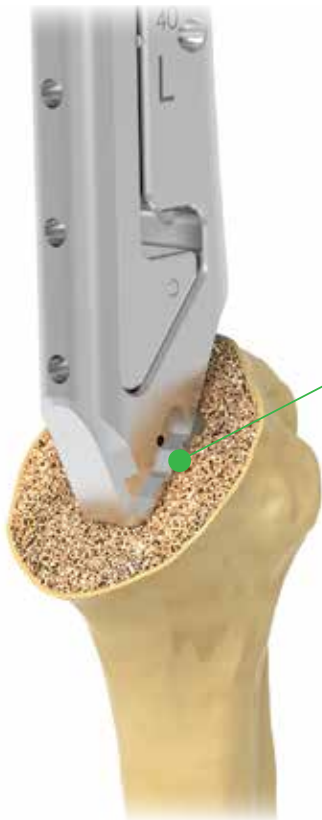

Figure 37
Insert Broach

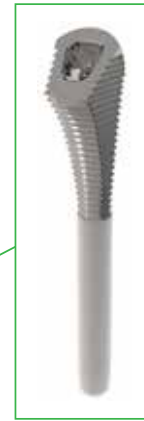

Figure 38a
Female Humeral Broach



Figure 38b
Modular Broach Handle Collar

Note: Check the collar for migration after each impaction/extraction.
Have an assistant cover the collar in case it becomes dislodged.

Broaching the Humeral Shaft

After the canal has been reamed, the smallest Broach (7mm) is attached to the **Broach Handle** (Figure 37). The Broach should be inserted into the canal at a version consistent with that of the cut surface (i.e., the broach collar should be flush with the resected surface). The canal should be sequentially broached until the size of the Broach matches that of the final Reamer. Each Broach should be impacted until contact is made between the metaphyseal surface and the broach collar. Broaching can be performed with or without the collar.

1) When using the collar, 0mm and 2mm options are available. If a flush impaction is desired, the 0mm is visible as shown in Figure 38b. Alternatively, a 2mm option is used to countersink the broach.

2) The Broach Handle can also be used without the Modular Broach Handle Collar if preferred.

As a visual check to assess version, the Retroversion Rod can be attached to the Broach Handle ("L" and "R" indicate appropriate side) and aligned with the patient's forearm (assuming the patient has a stable elbow). The Retroversion Handle, when aligned with the forearm, has options that indicate 0, 10, 20, 30 and 40 degrees of retroversion. It is the surgeon's preference how much retroversion should be used, as this will limit internal rotation.

Note: The Stem Extraction Tool is also an alternative option if the broach becomes countersunk too far (Figure 32).

Note: The Broach is securely locked to the Broach Handle when the trigger is returned to the starting position.

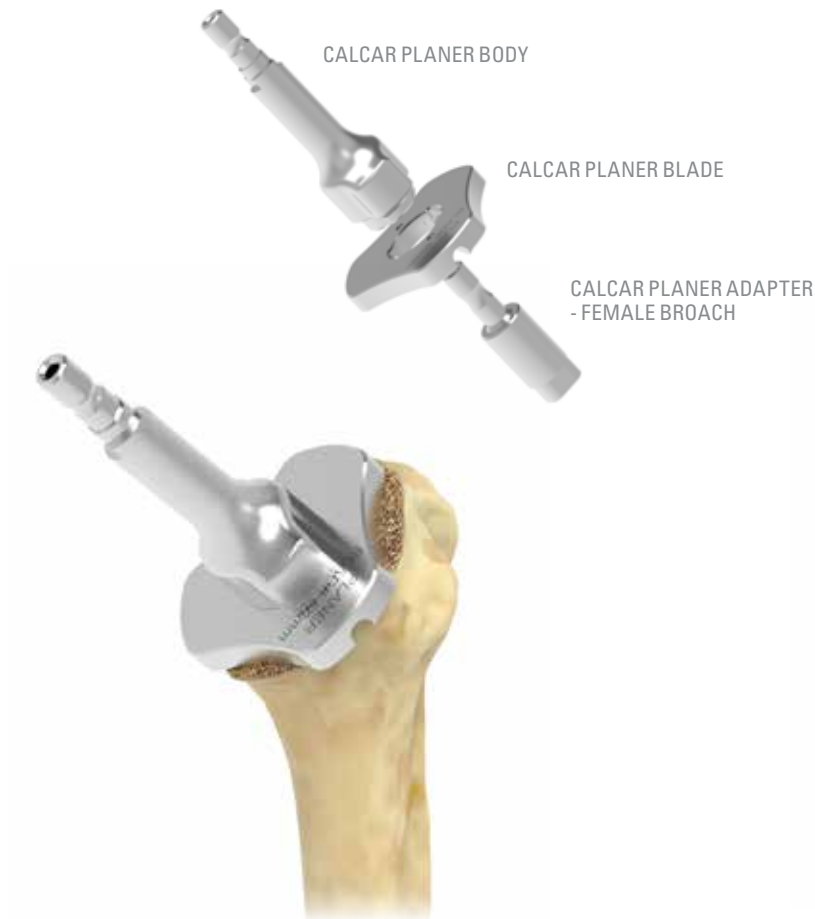

Figure 39

Plane Resected Humeral Head



Figure 40

Place Humeral Protector

Planing

Planing of the resected humeral head surface is also available. Planing may be conducted off of both the broach, utilizing the **Calcar Planer Adapter - Female Broach**, or the final stem, through the final stem **Calcar Planer Adapter - Stem** (*Figure 39*).

Humeral Stem Protector

The Humeral Protector should be placed onto the proximal portion of the implanted broach to protect the resected surface during glenoid preparation (*Figure 40*).

DETAILED OPERATIVE TECHNIQUE

PREPARING THE GLENOID

STEP 4: PREPARING THE GLENOID

Glenoid Exposure

Retractors are provided to aid in glenoid exposure. A posterior glenoid retractor (e.g. **Wolfe Retractor**) should be used to displace the proximal humerus posteriorly. A dual point glenoid retractor is then placed anteriorly along the glenoid neck. Hohmann Retractors are placed superiorly and inferiorly around the glenoid.

The glenoid labrum is excised circumferentially to expose the entire surface of the glenoid. Any remaining portions of the biceps tendon also should be excised. There is often a significant amount of tissue around the glenoid that represents bursal tissue and remnants of rotator cuff tendons. This should be excised to enhance visualization. The superior, anterior and inferior capsule should be released both for exposure and mobilization. A posterior capsular release may be beneficial to allow the proximal humerus to be retracted posteriorly for adequate glenoid exposure.

At this point, the degree and location of glenoid erosion can be visualized. This should be carefully and completely assessed so that glenoid reaming can be performed to provide proper orientation of the glenoid component. Exposure of the glenoid also will be facilitated by use of specific retractors. For a deltopectoral approach, a posterior glenoid retractor is essential. The **Small Forked Retractor** and **Wolfe Retractors** provided in the instrument set can be useful for this purpose. Levering retractors should be placed anteriorly, superiorly and inferiorly to expose the glenoid margins.

When a superior approach is used, the inferior capsular release is particularly important. The Small Forked Retractor can then be placed inferiorly to retract the proximal humerus posteroinferiorly for glenoid exposure. Levering retractors should be placed anteriorly, superiorly and posteriorly as described.

Note: While the Equinox Glenoid Plate does not need to be inferiorly tilted or angled, it should not be implanted with a superior tilt. A neutral orientation is ideal.

Reaming the Glenoid

The Equinox Reverse System provides two options to ream the glenoid: 1) **Pilot Tip** and 2) **Cannulated** (Figures 41a and 41b). The Cannulated Reamers rotate about a 3.2mm K-wire and provide the surgeon maximum precision. Ensure that the glenoid is reamed up to the appropriate size glenosphere.

Note: Avoid applying a bending force to the Pilot Tip Reamer Driver or using the Driver to retract the humeral head as this may cause fracture of the 3.2mm K-wire or pilot tip.



Figure 41a
Modular rTSA Reamer and Pilot Tip Driver



Figure 41b
Modular rTSA Reamer and
Cannulated Glenoid Reamer Driver



Figure 42a
Superolateral Approach



Figure 42b
Deltopectoral Approach

Regardless of the reaming option, the **Reverse Glenoid Baseplate Drill Guide** and **baseplate** should be aligned **1-2mm distal to the inferior glenoid rim to avoid scapular notching** (*Figures 42a and 42b*). This ensures the glenosphere is properly positioned in a superior-inferior position.

DETAILED OPERATIVE TECHNIQUE

PREPARING THE GLENOID

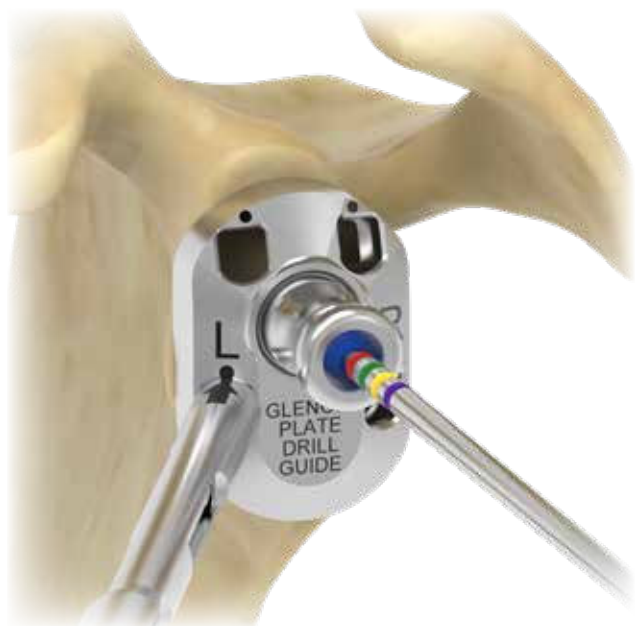

Figure 43
Drill 3.2mm Pilot Hole



Figure 44
Ream the Glenoid

Pilot Tip Reaming

Attach the **Reverse Glenoid Baseplate Drill Guide** to the **Modular Glenoid Guide Handle** by **matching the laser marking on both the Glenoid Sizer and Handle**, as shown in figure 43.

If using the Pilot Tip Reamers, the 3.2mm pilot hole is drilled through the K-wire Adapter and Modular Glenoid Plate Drill Guide to create the central axis for reaming the glenoid (Figure 43). It is suggested that the surgeon drill at least to the **orange depth marker** when making the pilot tip hole.

Next, connect the appropriately sized **Modular Reverse Reamer** to the **Pilot Tip Glenoid Reamer Driver**.

Note: Verify that the handle mechanism is locked on the sizer prior to inserting into the wound.

Note: Check that the reamer or drill is engaged on the driver handle before starting.

Note: Start the reamer prior to engaging bone.

Note: Avoid applying a bending force to the 3.2mm K-wire as this may cause fracture.

The pilot tip is placed into the drilled pilot hole and the glenoid is sequentially reamed until any pre-identified glenoid erosions are corrected and the glenoid surface has been fully contoured (Figure 44). Reaming begins with the Reverse Shoulder Starter Reamer and progresses to the 38mm and 42mm sizes based upon the anticipated size of the glenosphere.

It is critical to ream to the size of the largest potential glenosphere that the surgeon might use to ensure that the glenosphere will fit on the face of the glenoid without peripheral bony impingement (i.e., the glenoid plate will already be fixed to the glenoid and upsizing the glenosphere during trialing will not be possible if the corresponding reaming has not already been performed).



Figure 45
Insert 3.2mm K-wire

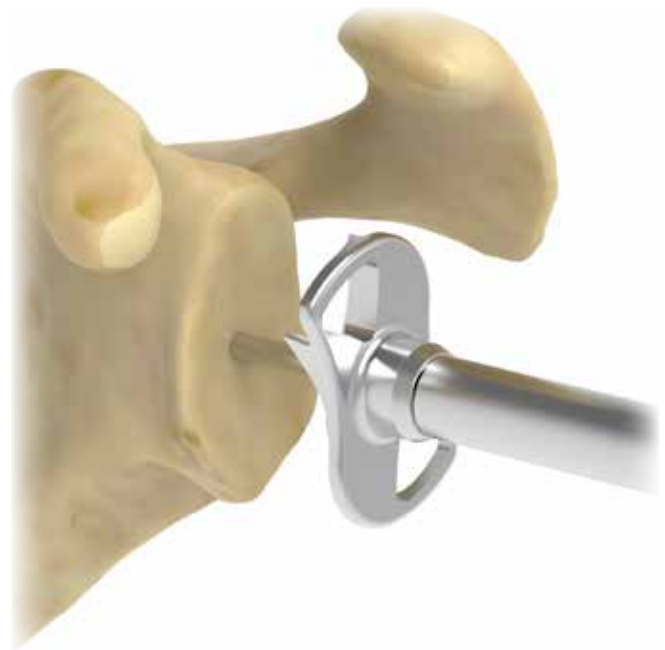

Figure 46
Ream the Glenoid

SURGICAL TIP
Start the reamer prior to engaging bone.

Cannulated Reaming

If using the Cannulated Reamers, drive the 3.2mm K-wire through the 3.2mm hole in the K-wire Adapter connected to the Modular Glenoid Plate Drill Guide (Figure 45). Connect the appropriately sized Modular Reamer to the Modular Cannulated Driver.

Reaming begins with the Reverse Shoulder Starter Reamer and progresses to the 38mm and 42mm sizes based upon the anticipated size of the glenosphere. Sequentially ream

the glenoid over the K-wire until any pre-identified glenoid erosions are corrected and the glenoid surface has been fully contoured (Figure 46).

It is critical to ream to the size of the largest potential glenosphere that the surgeon might use to ensure that the glenosphere will fit on the face of the glenoid without peripheral bony impingement (i.e. the glenoid plate will already be fixed to the glenoid and upsizing the glenosphere during trialing will not be possible if the corresponding reaming has not already been performed).

DETAILED OPERATIVE TECHNIQUE

PREPARING THE GLENOID



Figure 47a
Pilot Tip Cage Hole Drilling

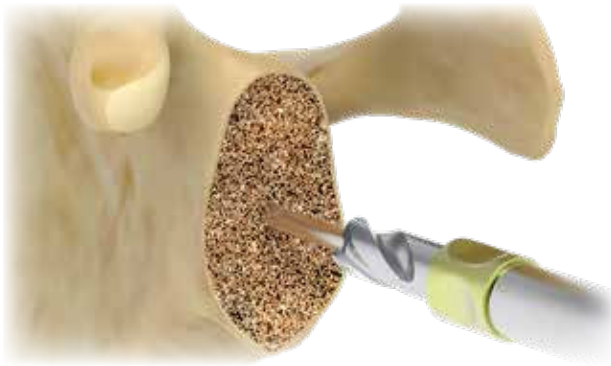

Figure 47b
Cannulated Cage Hole Drilling

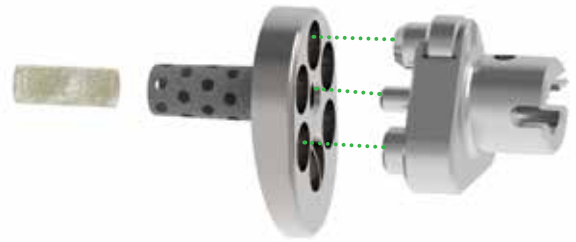

Figure 48
Assemble the Glenoid Plate with Bone Graft

Drill Cage Hole

After reaming has been completed, if using the pilot tip method, connect the Modular Center Peg Drill to the Cannulated Glenoid Reamer Driver and drill the cage hole through the Drill Guide (*Figure 47a*). For the Cannulated method, connect the **Modular Cannulated Center Peg Drill** to the Cannulated Glenoid Reamer Driver and drill the cage hole over the 3.2mm Pin **without** the Guide (*Figure 47b*). The Glenoid Plate Drill is 7.3mm in diameter. The Glenoid Plate cage is tapered and varies in diameter between 7.5mm at its end to 8.1mm where it joins the back of the Glenoid Plate.

Note: The standard size Modular Center Peg Drill and Modular Cannulated Center Peg Drill are indicated with a gold head (*Figure 47a and 47b*).

Bone Graft for Glenoid Plate

Two options exist for placing bone graft in the glenoid plate's cage (*Figure 48*).

1) Using the **Glenoid Plate Coring Reamer** to create a 6mm autograft bone column from the humeral head, or other suitable location as deemed appropriate by the surgeon, and inserting the bone column directly into the cage.

2) Placing allograft (e.g., **1cc of either Optecure® with ccc or Optecure in a syringe**) or morselized autograft manually into the cage.

Note: Take care to prevent bone graft from getting on the screw-hole threads as this could prevent adequate screw engagement.



Figure 49
Insert Glenoid Plate



Figure 50
Implant Glenoid Plate

Implanting the Glenoid Plate

The laser mark of the baseplate inserter will line up with the superior hole of the Glenoid Plate such that the central pin aligns with the threaded central hole and the peripheral legs connect to the bottom peripheral holes of the Glenoid Plate (Figure 48).

Once the cage hole is drilled, the Glenoid Plate is attached to the **Glenoid Baseplate Impactor/Inserter and Impactor Handle** and the Glenoid Plate is press-fit into position taking care to respect the correct rotational orientation (Figure 49).

WARNING: Don't assemble or disassemble devices in the surgical field.

Note: When inserting the final implant, keep the inserter pointed up with a hand underneath until the implant is in the wound.

Note: Remove inserter by pulling straight back. Do not bend and pull.

Four of the six potential screw locations that will provide optimal fixation and support of the glenoid plate are identified. Primary reverse shoulders will most typically use the superior and three inferior holes based on the anatomy of the native glenoid. The two peripheral holes on the superior part of the plate are intended for revision cases in which the native glenoid bone is compromised. However, each case should be individualized and the six holes provide the surgeon with additional options to maximize fixation of the Glenoid Plate (Figure 50).

DETAILED OPERATIVE TECHNIQUE

PREPARING THE GLENOID



Figure 51
Drill Screw Hole



Figure 52
Implant Screw

Four holes should be drilled using the **Adjustable Angle Drill Guide** and the **3.2mm Drill** (*Figure 51*), taking note of the depth of each hole using either the color-coded drill or the traditional depth guide. Each hole allows 30 degrees of angular variability so the orientation of the screws can be selected to maximize purchase.

Note: *The central cage of the glenoid plate limits the angular variability to 30 degrees for converging anterior, posterior and superior screws.*

The anterior and posterior screws should be inserted where the surgeon feels the best bone purchase can be achieved, taking note not to drill into the central cage of the Glenoid Plate (*Figure 52*).

Length (mm)	Diameter (mm)	Color-code
18	4.5	White
22	4.5	Black
26	4.5	Orange
30	4.5	Blue
34	4.5	Red
38	4.5	Green
42	4.5	Yellow
46	4.5	Purple

Table 5
Compression Screws



Figure 53
Insert Locking Caps

The 4.5mm **Compression Screws** are provided in lengths between 18mm and 46mm, in 4mm increments. The appropriately sized Compression Screws (*Table 5*) are inserted into the drilled holes to achieve fixation and compression of the Glenoid Plate to the glenoid. If power is used to initially insert the screws, caution should be taken to perform the final seating by hand. This will maximize fixation and avoid stripping of the screw head and/or driver.

A **Ratcheting Screw Driver Handle** and **Hex Screw Driver** are included in the instrument set to facilitate the placement and tightening of the screws.

After all Compression Screws are tightened by hand, as deemed appropriate by the orthopaedic surgeon, the surgeon should insert the **Locking Caps** into each screw hole. This will lock each Compression Screw and prevent the screws from backing out. Each Locking Cap is inserted perpendicular to the plate with the exception of the inferior one, which must be threaded at a 15-degree superior tilt (*Figure 53*).

DETAILED OPERATIVE TECHNIQUE

PREPARING THE GLENOID

Size	Color of Trials
38	Blue
42	Yellow

Table 6
Color-coded Trials

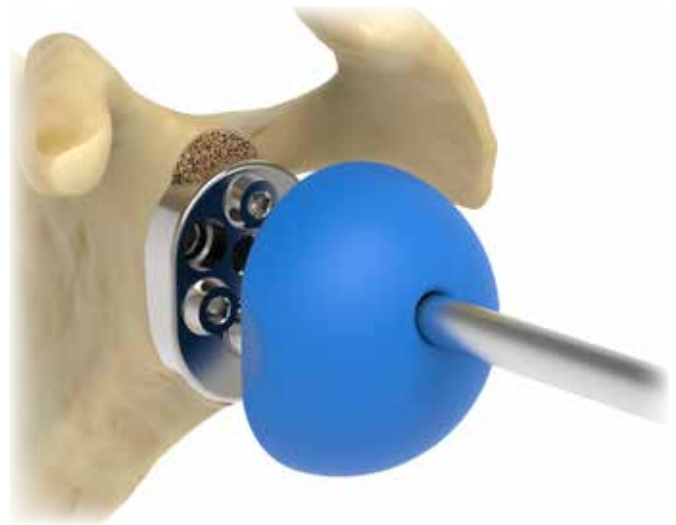

Figure 54
Tapered Pilot Tip Glenosphere Insertor

Inserting the Glenosphere Trial

Attaining adequate glenoid exposure is critical for this step, especially posterior glenoid exposure. A posterior glenoid retractor included in the set can help provide the posterior clearance necessary to implant the **Glenosphere**.

See *Table 6* for glosphere trial sizes. Take note that unlike circular baseplates, the anatomical shape of the Equinox Glenoid Plate mandates that the Glenosphere can only fit in one specific orientation (i.e., the superior/inferior axis of the glenoid).

Tapered Pilot Tip Glenosphere Insertor: Attach the **T-Handle** to the inserter. Align the T-Handle in the north/south axis of the glosphere to ensure that it is properly oriented with the Glenoid Plate. Once the glosphere is seated on the baseplate, apply digital pressure to ensure the glosphere stays on the baseplate and remove the inserter. **Do not attempt to impact the Tapered Pilot Glenosphere Insertor once the glosphere is seated** (*Figure 54*).

Note: When using the glosphere insertors, keep a hand under the glosphere until it is positioned in the wound.

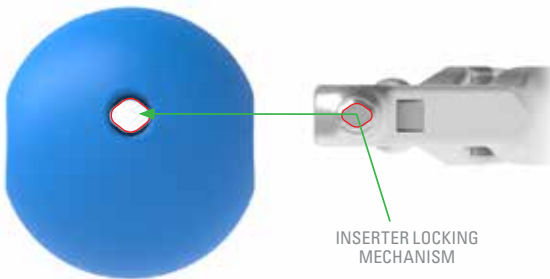

INSERTER LOCKING MECHANISM



Figure 55

Dolphin Glenosphere Inserter

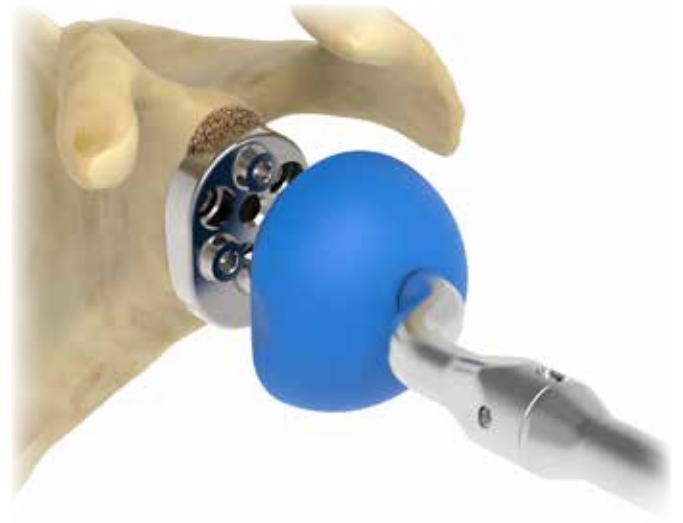

Figure 56

Klimo Glenosphere Inserter

Dolphin Glenosphere Inserter: The tip of the Glenosphere Inserter is inserted into the central hole of the Glenosphere (*Figure 55*). The clocking features must be aligned to maintain rotational stability. The handle is angled relative to the tip, which allows for slight angulation out of the joint. Once inserted into the central hole, squeeze the handles to lock the Glenosphere onto the inserter. Maintain a firm grip on the handles of the Glenosphere Inserter to allow for the best control. Once fully seated on the Glenosphere, release the locking mechanism to remove the inserter from the seated Glenosphere, while applying digital pressure.

Klimo Glenosphere Inserter: Attach the Klimo Inserter to the Impactor Handle (*Figure 56*).

WARNING: Don't assemble or disassemble devices in the surgical field.

The curved axis of the inserter (the elbow of the inserter) should be aligned at the three o'clock position for a right shoulder or the nine o'clock position for the left shoulder. For rotational stability and axial control, a mallet can be used to engage the inserter on the glenosphere by striking the top of the impactor handle. The Klimo Inserter helps to keep the glenosphere aligned with the long axis of the Glenoid Plate during insertion. **Do not attempt to impact the Klimo Inserter once the glenosphere is seated.**

Finally, the Glenosphere Trial is connected to the Glenoid Plate with the Glenosphere Locking Screw to prevent the Glenosphere from disengaging during trial reductions (*Figure 57*).

DETAILED OPERATIVE TECHNIQUE

TRIALING THE HUMERAL ADAPTER TRAY & LINER



Figure 57
Glenosphere Locking Screw



Figure 58a
Humeral Tray Trial



Figure 58b
+5mm Humeral Tray
Trial Adapter

SURGICAL TIP

The Glenosphere Locking Screw is placed perpendicular to the hole within the Glenosphere and the Glenoid Baseplate, which are aligned with one another. Note that the outer periphery of the apical hole of the Glenosphere is curved because of the intersection of the articular curvature on the superior surface of the device. The Glenosphere Locking Screw should not be inserted perpendicular to this articular curvature but instead be inserted perpendicular to the Baseplate and hole within the Glenosphere (Figure 57).

SURGICAL TIP

It is critical that the Humeral Adapter Tray be oriented such that the line on the Adapter Tray aligns with the lateral fin of the Humeral Stem.

STEP 5: TRIALING THE HUMERAL ADAPTER TRAY & LINER

The **+0mm Humeral Tray Trial** is attached to the Humeral Broach and secured by threading the captured screw into the threads of the Broach (Figure 58a).

For larger offsets, add the **+5mm EQ Humeral Tray Trial Spacer** to add 5mm of offset (Figure 58b). If more offset is needed, remove the +0mm and +5mm tray trials and attach the **+10mm EQ Humeral Tray Trial**. Combinations of trays and liners can achieve the following offsets: +0, +2.5, +5.0, +7.5, +10.0, +12.5mm, +15mm, and +17.5mm. It is important to note that the assembled humeral component will have a humeral neck angle of 145 degrees because the liner adds 12.5 degrees to the stem's 132.5 degree neck angle.

Note: Avoid using a sliding motion when separating Tray Trials and Liner Trials.



Figure 59
Humeral Tray Trial with Liner

To insert the **Humeral Liner Trial** into the Trial Tray, the underside asymmetric-connecting feature should be appropriately aligned, and the liner/tray trials should be pressed together until they engage. To disengage the trials, the tip of the **Humeral Liner Removal Tool** is inserted into the recessed region of the trial tray and the instrument is turned like a key until the Humeral Liner Trials and plate trials are disengaged, thereby freeing the Liner (*Figure 59*).

The stability of the implant is assessed during a trial reduction. The shoulder should be placed through a range of motion to assess the stability of the construct. While each surgeon may have their own system to assess stability, we approach the trial reduction as follows:

1) With reduction and arm by the side, the lateral deltoid and conjoined tendon should be under tension. The expectation is

that the reduction should require more distraction to achieve than reduction of non-constrained implants.

2) Forward elevation and abduction should be assessed to determine that the construct is stable and the components do not impinge on bony structures.

3) Internal and external rotation should be assessed with the humerus at 0 and 90 degrees to assess stability. Although maximal ranges of external rotation may produce some impingement posteriorly, it should not result in instability.

4) With the arm at the side, there should be no evidence of impingement that results in distraction of the implants.

Note: *The Tray Trial or Liner Trial may become disengaged in tight shoulders or during impingement.*

DETAILED OPERATIVE TECHNIQUE

INSERTING THE FINAL IMPLANTS

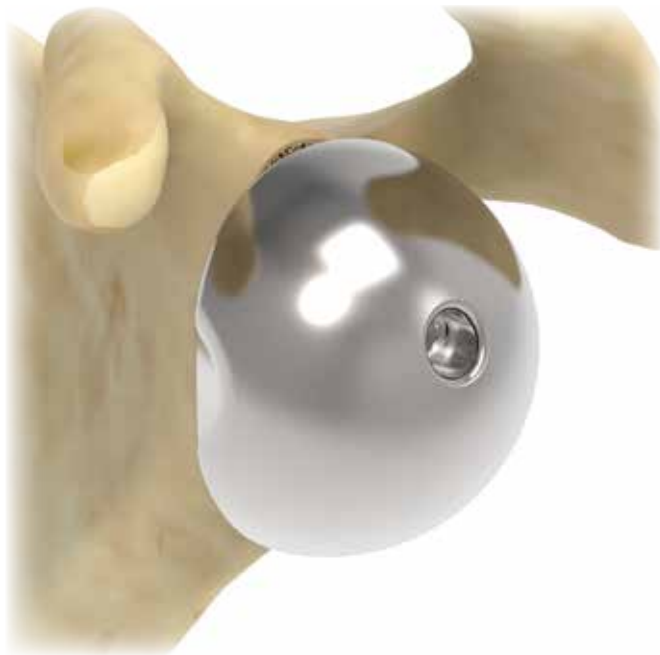

Figure 60
Insert Definitive Glenosphere and Screw

If additional stability is required based upon the trial reduction, constrained liner options are provided in the same offset as the standard liners. While constrained liners will provide better stability, it is important to note they will also reduce the potential range of motion that can be achieved. If trial components are changed, additional closed reductions and assessments should be performed to confirm that the desired stability has been obtained. In the unusual situation in which the +0mm liner is too tight, the humeral liner trial can pop out from the tray trial. The humeral component should then be removed and additional bone should be resected using the methods described.

STEP 6: INSERTING THE FINAL IMPLANTS

The Humeral Liner Trial, Humeral Adapter Tray Trial and Glenosphere Trial are removed. The final Glenosphere is

implanted in the same manner used with the Glenosphere Trial. Glenosphere is not a morse taper and should not be impacted. The glenosphere is secured with a locking screw using the 3.5mm Hex Driver (*Figure 60*).

SURGICAL TIP

If you hear the Glenosphere Locking Screw “squeaking” prior to the screw head being recessed in the Glenosphere apical hole—STOP. The Glenosphere is not seated on the baseplate correctly. Run an instrument along the backside of the Glenosphere to feel for the plate. You should not feel any of the plate if the Glenosphere is seated properly. You can also visually assess this anteriorly.



Figure 61
Insert Definitive Stem



Figure 62
rTSA Screw Starter Tool

The arm should be placed in extension and the **Broach Handle** should be attached to the humeral broach. The Broach can now be removed in order to prepare for cementing the stem. Downsizing the definitive stem two sizes from the trial will result in a 1.5mm proximal cement mantle and a 2mm distal cement mantle (eg. if a 13mm Broach was used, then an 11mm Stem should be inserted). Adequate stability can be obtained with a minimal cementation technique. Cementing of the stem should proceed based upon the surgeon's preferred technique (*Figure 61*). The Stem Inserter should be used with the stem impacted into place until it is at the level of the bony surface.

The final Humeral Adapter Tray is preliminary attached to the Humeral Stem via the torque screw using the **rTSA Screw Starter Tool**. The rTSA starter screw should not be used to break the Torque screw (*Figure 62*).

SURGICAL TIP

It can be helpful to place the Torque Defining Screw through the humeral tray before connecting it to the stem so that the threads engage more easily.

Failure to fully engage the UHMWPE plug on the screw head may prevent the screw head from being retained by the torque defining screw driver.

DETAILED OPERATIVE TECHNIQUE

INSERTING THE FINAL IMPLANTS

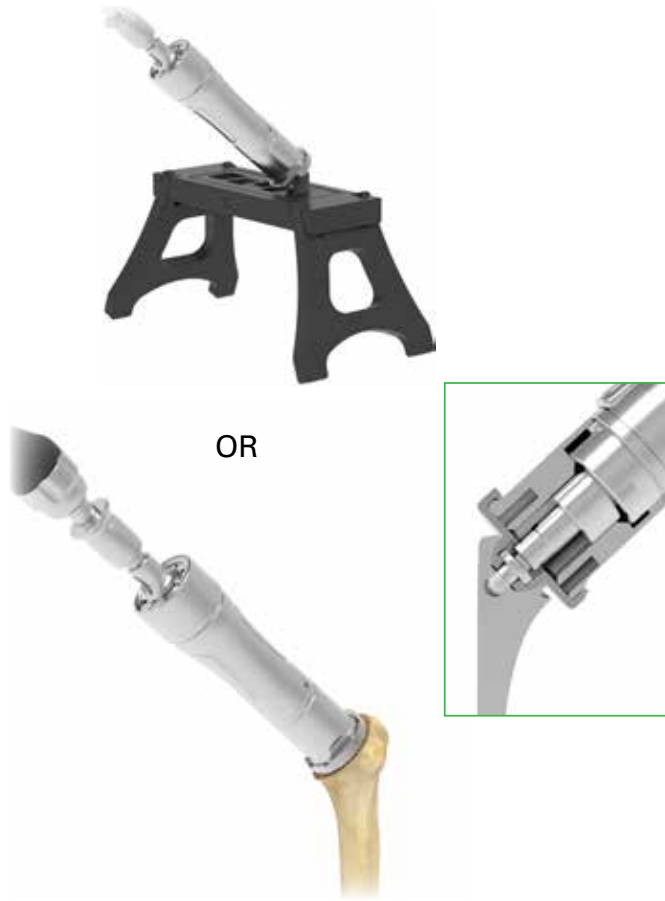

Figure 63a
Lock Torque Defining Screw



Figure 63b
Lock Torque Defining Screw

It is critical that the Humeral Adapter Tray be oriented properly, which requires aligning the indicator mark on the tray with the lateral fin on the stem. The plate is locked to the stem by applying 11 N·m torque to the Screw with the supplied **Modular Counter Torque Handle, Reverse Counter Torque Tip, and Geared Torque Screw Driver** (Figure 63a). Choose the appropriate Counter Torque Tip based on the size tray used (+0,+5,+10,+15* tip). The Reverse Counter Torque Tip needs to be connected to the Modular Counter Torque Handle and then attached to the Humeral Tray, in the same fashion as the trial liner. Once this is in place, the geared torque handle will slide through the center of the reverse counter torque handle with the laser marked wording "Lateral" facing laterally on the final humeral tray.

The superior portion of the Screw will disengage when 11 N·m is reached (and will remain in the Geared Torque Screw Driver, which will need to be removed before sterilization).

The final Humeral Liner is attached to the Humeral Adapter Tray by orienting the asymmetric connecting features and sliding the lip of the liner under the superior rim of the Humeral Tray.

Note: Please note that the superior portion of the Torque Defining Screw should be removed before sterilization by inserting a 3.2mm K-wire through the top of the Geared Torque Screw Driver.

Note: Do not leave the Geared Torque Screw Driver of the Modular Counter Torque Handle unsupported in the wound.

*Special Order

Size	Color of Impactor Tips
38	Blue
42	Yellow

Table 7
Impactor Tips



Figure 64
Implant Definitive Liner

SURGICAL TIPS

- The big lip of the poly should be inferior with the Equinox Reverse.

Finally, the apical mushroom of the Humeral Liner is engaged to the apical lock of the Humeral Adapter Tray by impacting the Humeral Liner with the appropriately sized **Humeral Liner Impactor Tip** (Table 7).

WARNING: Don't assemble or disassemble devices in the surgical field.

The humeral liner should be impacted until it sits flush on the Humeral Adapter Tray (Figure 64). At this point, the humeral component should be reduced onto the Glenosphere. Range of motion and stability should be assessed to confirm the

findings from the trial reduction. Once this assessment has been made, closure can be performed.

Alternatively, the stem, tray and liner can be assembled using the **Back Table Assembly Stand** first and then placed as a unit into the humerus with cement. The disadvantage of this technique is that further implant trialing is not possible, so it should only be used when the surgeon is confident about the thickness of the tray and liners based on the previous trialing. The advantage of this technique is that the shoulder can be reduced and the surgeon can begin closing while the cement is hardening.

Note: Verify that the stem is in the correct hole and in the correct orientation before impaction. The hole size and the stem should both face the same direction. Improper use can lead to the stem becoming stuck in the insert.

DETAILED OPERATIVE TECHNIQUE

DELTOPECTORAL CLOSURE

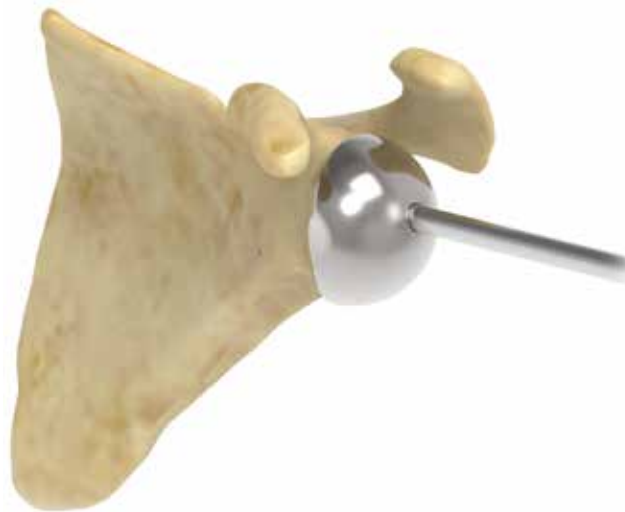

Figure 65
Glenosphere Removal

STEP 7: DELTOPECTORAL CLOSURE

If the subscapularis tendon was divided during the approach it should be reattached at this time. The method of reattachment is based upon surgeon preference and is generally determined by the method of tenotomy performed. The repair will be either tendon-to-tendon or tendon-to-bone using #2 heavy non-absorbable sutures. A drain should be used at the surgeon's discretion to counteract the potential for hematoma formation. The use of a drain will limit the risk of hematoma formation. The deltopectoral interval is closed followed by closure of the subcutaneous tissue and the skin. The upper extremity is then placed in a sling and swathe.

Glenosphere Removal

If the Glenosphere needs to be removed, a glenosphere inserter can be used as a removal instrument or the glenosphere can be removed by hand after screw removal. If the Glenosphere will not come off by hand, inset the Hex screw driver into the sphere after removal of the screw and rock your hand up and down (*Figure 65*).



Figure 66
Humeral Liner Removal



Figure 67
Humeral Tray Removal

Humeral Liner Removal

If the final Humeral Liner needs to be removed, a **Humeral Liner Removal Tool** is provided. Insert the Humeral Liner Removal Tool in each cut out of the Humeral Tray (*Figure 66*) and twist until the Humeral Liner has been removed.

Humeral Tray Removal

Once the final Humeral Liner has been removed, choose the +15mm Reverse Counter Torque Tip. Connect this torque tip to the Modular Counter Torque Handle and attach the final construct to the Humeral Tray. After this is attached to the Humeral Tray, use the Torque Defining Screw Removal Instrument connected to the Ratcheting T-handle and place this through the Modular Counter Torque Handle (*Figure 67*). Remove the Torque Screw by twisting the Ratcheting T-handle and using the Modular Counter Torque Handle to prevent the stem from spinning. The Humeral Tray can now be removed and discarded.

IMPLANT LISTING

CATALOG NO.	PART DESCRIPTION
300-01-07	Humeral Stem, Primary, Press-Fit, 7mm
300-01-08	Humeral Stem, Primary, Press-Fit, 8mm
300-01-09	Humeral Stem, Primary, Press-Fit, 9mm
300-01-10	Humeral Stem, Primary, Press-Fit, 10mm
300-01-11	Humeral Stem, Primary, Press-Fit, 11mm
300-01-12	Humeral Stem, Primary, Press-Fit, 12mm
300-01-13	Humeral Stem, Primary, Press-Fit, 13mm
300-01-14	Humeral Stem, Primary, Press-Fit, 14mm
300-01-15	Humeral Stem, Primary, Press-Fit, 15mm
300-01-17	Humeral Stem, Primary, Press-Fit, 17mm
306-01-08	Humeral Long Stem, 8 x 175mm
306-02-08	Humeral Long Stem, 8 x 215mm
306-02-10	Humeral Long Stem, 10 x 200mm*
306-02-12	Humeral Long Stem, 12 x 200mm*
300-10-15	Anatomic Replicator Plate, 1.5mm o/s
300-10-45	Anatomic Replicator Plate, 4.5mm o/s
300-20-02	Torque Defining Screw Kit
310-01-38	Humeral Head, Short, 38mm
310-01-41	Humeral Head, Short, 41mm
310-01-44	Humeral Head, Short, 44mm
310-01-47	Humeral Head, Short, 47mm
310-01-50	Humeral Head, Short, 50mm
310-01-53	Humeral Head, Short, 53mm
310-02-38	Humeral Head, Tall, 38mm
310-02-41	Humeral Head, Tall, 41mm
310-02-44	Humeral Head, Tall, 44mm
310-02-47	Humeral Head, Tall, 47mm
310-02-50	Humeral Head, Tall, 50mm
310-02-53	Humeral Head, Tall, 53mm
314-02-02	Glenoid, Pegged, Alpha, Small
314-02-03	Glenoid, Pegged, Alpha, Medium
314-02-04	Glenoid, Pegged, Alpha, Large
314-02-13	Glenoid, Pegged, Beta, Medium
314-02-14	Glenoid, Pegged, Beta, Large
314-02-15	Glenoid, Pegged, Beta, Extra Large
314-13-02	Glenoid, Cage, Alpha, Small
314-13-03	Glenoid, Cage, Alpha, Medium
314-13-04	Glenoid, Cage, Alpha, Large
314-13-13	Glenoid, Cage, Beta, Medium
314-13-14	Glenoid, Cage, Beta, Large
314-13-15	Glenoid, Cage, Beta, Extra Large

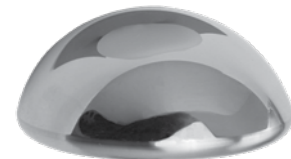

CATALOG NO. PART DESCRIPTION

320-10-00 Humeral Adapter Tray, +0
 320-10-05 Humeral Adapter Tray, +5
 320-10-10 Humeral Adapter Tray, +10
 320-10-15 Humeral Adapter Tray, +15*



320-38-00 Humeral Liner, 38mm, +0
 320-38-03 Humeral Liner, 38mm, +2.5
 320-38-10 Humeral Liner, Constrained, 38mm, +0
 320-38-13 Humeral Liner, Constrained, 38mm, +2.5
 320-42-00 Humeral Liner, 42mm, +0
 320-42-03 Humeral Liner, 42mm, +2.5
 320-42-10 Humeral Liner, Constrained, 42mm, +0
 320-42-13 Humeral Liner, Constrained, 42mm, +2.5
 320-46-00 Humeral Liner, 46mm, +0*
 320-46-03 Humeral Liner, 46mm, +2.5*
 320-46-10 Humeral Liner, Constrained, 46mm, +0*
 320-46-13 Humeral Liner, Constrained, 46mm, +2.5*



320-20-18 Compression Screw/Locking Cap Kit, 4.5 x 18mm, White
 320-20-22 Compression Screw/Locking Cap Kit, 4.5 x 22mm, Black
 320-20-26 Compression Screw/Locking Cap Kit, 4.5 x 26mm, Orange
 320-20-30 Compression Screw/Locking Cap Kit, 4.5 x 30mm, Blue
 320-20-34 Compression Screw/Locking Cap Kit, 4.5 x 34mm, Red
 320-20-38 Compression Screw/Locking Cap Kit, 4.5 x 38mm, Green
 320-20-42 Compression Screw/Locking Cap Kit, 4.5 x 42mm, Yellow
 320-20-46 Compression Screw/Locking Cap Kit, 4.5 x 46mm, Purple



320-15-05 Glenosphere Locking Screw



320-01-38 Glenosphere, 38mm
 320-01-42 Glenosphere, 42mm
 320-01-46 Glenosphere, 46mm*



320-15-01 Glenoid Plate



320-20-00 Reverse Shoulder, Torque Defining Screw Kit



321-52-07 3.2mm Drill W/AO



321-52-10 3.2mm Short Threaded K-wire - 2PK



321-52-09 3.2mm Trocar Tip K-wire



INSTRUMENT LISTING

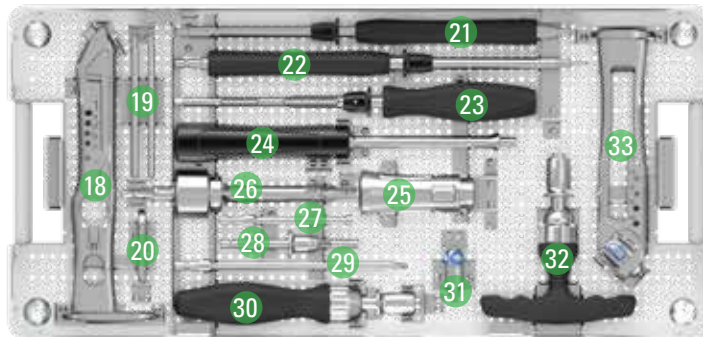
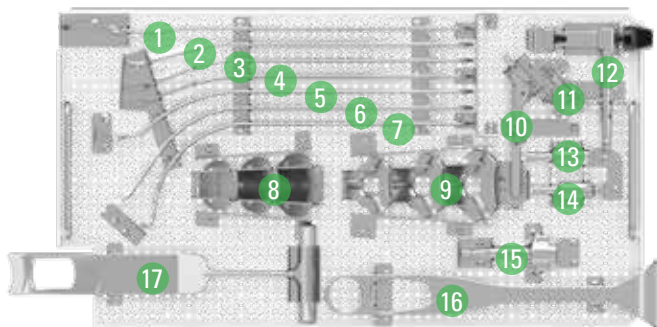

EQUINOXE ERGO CORE INSTRUMENT TRAY (KIT-311X)

1	Darrach Retractor	317-11-03
2	Small Forked Retractor	317-21-01
3	Hohmann Retractor	317-11-06
4	Hohmann Retractor	317-11-06
5	Wolfe Retractor	317-11-08
6	Dual Point Glenoid Retractor	317-11-04
7	Humeral Head Retractor	317-11-02
8	Small Humeral Protector	301-08-21
8	Medium Humeral Protector	301-08-41
8	Large Humeral Protector	301-08-61
9	Calcar Planer Blade 44mm	301-09-44
9	Calcar Planer Blade 50mm	301-09-50
9	Calcar Planer Blade 56mm	301-09-56
10	132.5 Degree Osteotomy Guide	311-11-13
11	IM Resection Guide	311-11-14
12	IM Guide Boom	311-11-11
13	Calcar Planer Adapter - Female Broach	301-09-01
14	Calcar Planer Adapter - Stem	301-09-02
15	Calcar Planer Body	301-09-00
16	Deltoid Retractor	317-21-06
17	Klimo Fukuda Retractor	317-21-05
18	EQII Broach Handle	301-05-02
19	Version Rod	301-05-20
20	Broach Collar	301-05-03
21	Cannulated Glenoid Reamer Driver	315-50-12
22	Pilot Tip Glenoid Reamer Driver	315-50-11
23	Modular Glenoid Guide Handle	315-52-11
24	Modular Impactor Handle	321-09-05*
25	Modular Counter Torque Handle	301-16-36
26	Geared Torque Screw Driver	321-16-69
27	Torque Defining Screw Removal Instrument	301-16-10
28	Glenoid Plate Coring Reamer	321-09-10
29	Hex Screw Driver 3.5mm	321-19-08
30	Non-Ratcheting Handle	301-09-90
31	Stem Extraction Tool	301-09-12
32	Ratcheting T-Handle	301-09-30
33	EQII Stem Inserter	301-09-20

*The Impactor Handle (321-07-05) can be used as a substitute as needed.

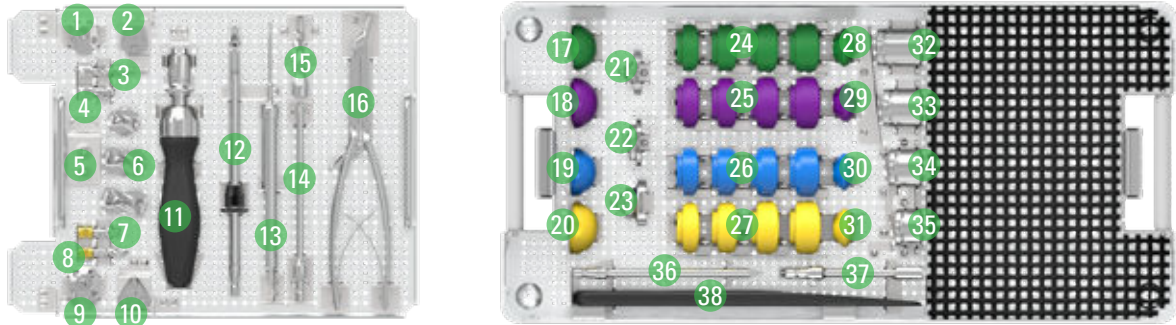

EQUINOXE ERGO rTSA HUM/GLEN INSTRUMENT TRAY (KIT-321T)

1	Drill guide, Small Glenoid Plate	321-35-20
2	Insertor, Small Glenoid Plate	321-35-23
3	Small Reverse Modular Pilot Tip Drill	315-52-60
4	Small Reverse Modular Cannulated Drill	315-52-66
5	K-wire adapter (2 Kits)	315-51-10
6	Modular Reverse Reamer Starter	321-50-01
6	Modular Reverse Reamer 38mm	321-50-38
6	Modular Reverse Reamer 42mm	321-50-42
7	Modular Cannulated Central Peg Drill (2 Kits)	315-52-65
8	Modular Central Peg Drill (2 Kits)	315-52-64
9	Reverse Glenoid Baseplate Drill Guide	321-52-33
10	Glenoid Baseplate Impactor/Insertor	321-19-14
11	Ratcheting Screw Driver Handle	301-09-80
12	Adjustable Angle Drill Guide	321-19-05
13	Glenoid Screw Depth Gage	321-19-09
14	Tapered Glenosphere Insertor	321-01-57
15	Klimo Glenosphere Insertor	321-01-51
16	Glenosphere Insertor	321-01-52
17	Small Reverse Glenosphere Trial, 36mm*	321-31-36
18	Small Reverse Glenosphere Trial, 40mm*	321-31-40
19	EQ 38mm Glenosphere Trial	321-06-38
20	EQ 42mm Glenosphere Trial	321-06-42
21	EQ Humeral Tray Trial +0	321-14-00
22	EQ Humeral Tray Trial +5mm	321-14-05
23	EQ Humeral Tray Trial +10mm	321-14-10
24	Small Reverse Humeral Liner Trial, 36mm, +0*	321-36-00
24	Small Reverse Humeral Liner Trial, 36mm, +2.5*	321-36-03
24	Small Reverse Humeral Liner Trial, 36mm, +0, Constrained*	321-36-10
24	Small Reverse Humeral Liner Trial, 36mm, +2.5, Constrained*	321-36-13
25	Small Reverse Humeral Liner Trial, 40mm, +0*	321-40-00
25	Small Reverse Humeral Liner Trial, 40mm, +2.5*	321-40-03
25	Small Reverse Humeral Liner Trial, 40mm, +0, Constrained*	321-40-10
25	Small Reverse Humeral Liner Trial, 40mm, +2.5, Constrained*	321-40-13
26	38mm Humeral Liner Trial +0	321-38-00
26	38mm Humeral Liner Trial +2.5	321-38-03
26	38mm Humeral Liner Trial Constrained +0	321-38-10
26	38mm Humeral Liner Trial Constrained +2.5	321-38-13
27	42mm Humeral Liner Trial +0	321-42-00
27	42mm Humeral Liner Trial +2.5	321-42-03
27	42mm Humeral Liner Trial Constrained +0	321-42-10
27	42mm Humeral Liner Trial Constrained +2.5	321-42-13
28	Humeral Liner Impactor Tip, 36mm*	321-09-36
29	Humeral Liner Impactor Tip, 40mm*	321-09-40
30	Humeral Liner Impactor Tip 38mm	321-09-38
31	Humeral Liner Impactor Tip 42mm	321-09-42
32	Reverse Counter Torque +0 tip	321-16-00
33	Reverse Counter Torque +5 tip	321-16-05
34	Reverse Counter Torque +10 Tip	321-16-10
35	Reverse Counter Torque +15 Tip	321-16-15
36	Humeral Liner Removal Tool	321-19-11
37	rTSA Screw Starter Tool	321-16-06
38	Shoehorn/Reduction Tool	321-19-10

*Small Reverse Glenosphere Trial, Humeral Liner Trial, and Humeral Liner Impactor Tip are not yet included in Kit-321T

INSTRUMENT LISTING

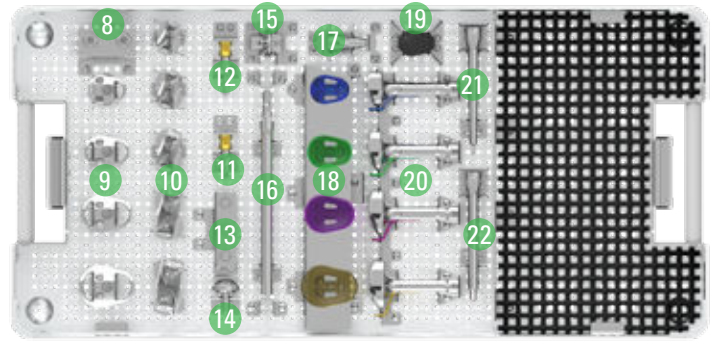
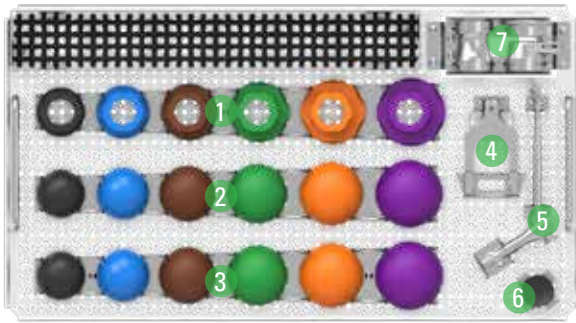

EQUINOXE ERGO aTSA HUM/GLEN INSTRUMENT TRAY (KIT-311T)

1	Plate Dial 38mm	301-13-38
1	Plate Dial 41mm	301-13-41
1	Plate Dial 44mm	301-13-44
1	Plate Dial 47mm	301-13-47
1	Plate Dial 50mm	301-13-50
1	Plate Dial 53mm	301-13-53
2	Short Head Trial 38mm	311-11-38
2	Short Head Trial 41mm	311-11-41
2	Short Head Trial 44mm	311-11-44
2	Short Head Trial 47mm	311-11-47
2	Short Head Trial 50mm	311-11-50
2	Short Head Trial 53mm	311-11-53
3	Tall Head Trial 38mm	311-12-38
3	Tall Head Trial 41mm	311-12-41
3	Tall Head Trial 44mm	311-12-44
3	Tall Head Trial 47mm	311-12-47
3	Tall Head Trial 50mm	311-12-50
3	Tall Head Trial 53mm	311-12-53
4	Head Removal Tool	311-09-01
5	Replicator Alignment Handle	301-16-41
6	Humeral Head Impactor Tip	311-09-07
7	Anatomic Counter Torque 1.5/4.5 Offset Tip	301-16-37
7	Anatomic Counter Torque 0 Offset Tip	301-16-38
8	K-wire adapter (2 Kits)	315-51-10
9	Glenoid Sizer Small	315-56-02
9	Glenoid Sizer Medium	315-56-03
9	Glenoid Sizer Large	315-56-04
9	Glenoid Sizer Extra Large	315-56-05
10	Modular aTSA Reamer Extra Small	315-50-01
10	Modular aTSA Reamer Small	315-50-02
10	Modular aTSA Reamer Medium	315-50-03
10	Modular aTSA Reamer Large	315-50-04
10	Modular aTSA Reamer Extra Large	315-50-05
11	Modular Cannulated Central Peg Drill	315-52-65
12	Modular Central Peg Drill	315-52-64
13	Modular Peripheral Peg Drill (3)	315-52-62
14	Peripheral Peg Drill Guide	315-57-04
15	Cement Pressurizer Peripheral Pegs	315-57-08
16	Peripheral Peg Driver	315-52-01
17	Cement Pressurizer Central Peg	315-57-07
18	Pegged Glenoid Trial Small	315-53-02
18	Pegged Glenoid Trial Medium	315-53-03
18	Pegged Glenoid Trial Large	315-53-04
18	Pegged Glenoid Trial Extra Large	315-53-05
19	Glenoid Impactor Tip	315-57-06
20	aTSA Glenoid Impactor Small	315-55-02
20	aTSA Glenoid Impactor Medium	315-55-03
20	aTSA Glenoid Impactor Large	315-55-04
20	aTSA Glenoid Impactor Extra Large	315-55-05
21	Peripheral Peg Extractor	315-57-18
22	Central Peg Extractor	315-57-17

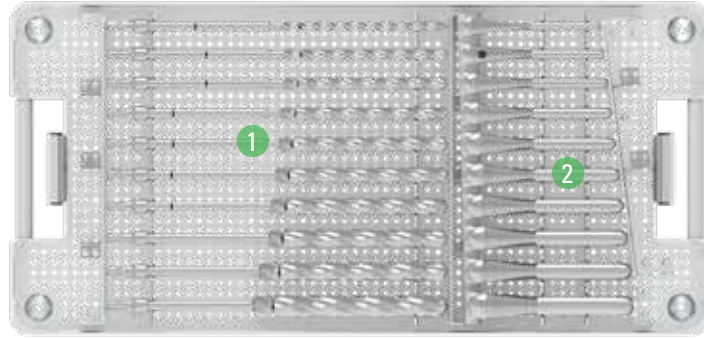

EQUINOXE ERGO REAMER AND BROACH INSTRUMENT TRAY (KIT-311R)

1	7mm Fluted Reamer	301-18-07
1	8mm Fluted Reamer	301-18-08
1	9mm Fluted Reamer	301-18-09
1	10mm Fluted Reamer	301-18-10
1	11mm Fluted Reamer	301-18-11
1	12mm Fluted Reamer	301-18-12
1	13mm Fluted Reamer	301-18-13
1	14mm Fluted Reamer	301-18-14
1	15mm Fluted Reamer	301-18-15
1	17mm Fluted Reamer	301-18-17
2	Humeral Female Broach 7mm	301-19-07
2	Humeral Female Broach 8mm	301-19-08
2	Humeral Female Broach 9mm	301-19-09
2	Humeral Female Broach 10mm	301-19-10
2	Humeral Female Broach 11mm	301-19-11
2	Humeral Female Broach 12mm	301-19-12
2	Humeral Female Broach 13mm	301-19-13
2	Humeral Female Broach 14mm	301-19-14
2	Humeral Female Broach 15mm	301-19-15
2	Humeral Female Broach 17mm	301-19-17

SYSTEM SPECIFICATIONS

(ALL DIMENSIONS IN MILLIMETERS)

HUMERAL STEM

Distal Diameter	Length*	Inherent Medial Offset	Material	Surface Finish		Geometry	
				Proximal	Distal	Proximal	Distal
7	100	7.5	Ti-6Al-4V	16 grade grit blast	Hi-Brite Polish	Trapezoidal	Cylindrical with Flutes
8	102.5						
9	105						
10	107.5						
11	110	8.5					
12	112.5	9.5					
13	115						
14	117.5						
15	120						
17	125						
19	127.5						

*Measured from distal tip to center of proximal spherical bore

LONG STEM

Distal Diameter	Length	Inherent Medial Offset
8	175	7.8
8	215	
10*	200	
11*	200	

*Special order

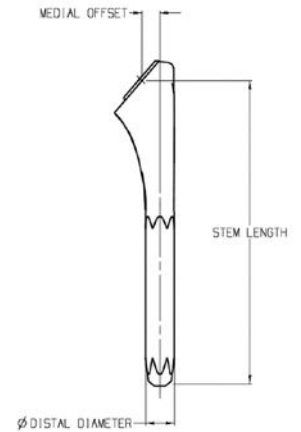

REPLICATOR PLATES

Offset	Material	Offset Ranges*		Angle Ranges (°)	
		Med/Lat	Ant/Post	Inclination	Version
1.5	Ti-6Al-4V	0-14	0-6	125-140	+/-7.5
4.5					

*Includes effect of head offsets

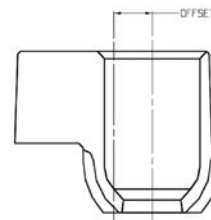

HUMERAL HEADS

Diameter	Height				Glenoid		
	Extra Short	Short	Tall	Expanded	Offset	Mate	Material
38	-	16	19	-	0	Alpha	Co-Cr
41	14	16	20	-	0		
44	15	17	21	-	1.5		
47	16	18	22	26	1.5		
50	17	19	23	27	1.5		
53	18	20	24	28	1.5	Beta	

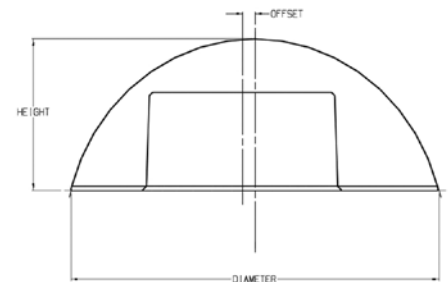

GLENOIDS

Sizes	Fixation	Material	Radial Mismatch	Shape
Small	Cage, Peg	Compression Molded UHMWPE	Mean: 5.5	Anatomic (Pear)
Medium				
Large				
Extra Large	Cage, Peg			

SYSTEM SPECIFICATIONS

(ALL DIMENSIONS IN MILLIMETERS)

HUMERAL LINER/HUMERAL TRAY OFFSET COMPARISONS

	+0mm Humeral Liners (Standard and Constrained)	+2.5mm Humeral Liners (Standard and Constrained)
+0 Humeral Tray	0	2.5
+5 Humeral Tray	5	7.5
+10 Humeral Tray	10	12.5

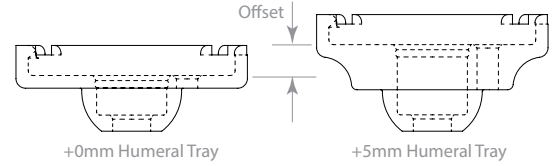

Note: When using a +0mm liner and +0mm tray, there will be a 9.3mm buildup between the face of the stem and the thinnest part of the liner.

HUMERAL LINER DEPTH COMPARISONS

	Standard Liner Depth (+0mm and +2.5mm)	Constrained Liner Depth (+0mm and +2.5mm)
38 Humeral Liners	8.5	12.0
42 Humeral Liners	8.8	12.6

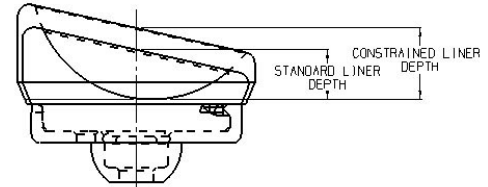

COMPRESSION SCREWS

Outer Diameter	Length	Color
4.5	18	White
	22	Black
	26	Orange
	30	Blue
	34	Red
	38	Green
	42	Yellow
	46	Purple

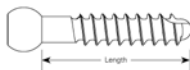

GLENOSPHERE/GLENOID PLATE

	Diameter	Thickness	Average Lateralization of Center of Rotation
38 Glenosphere	38	23.1	2
42 Glenosphere	42	25.1	

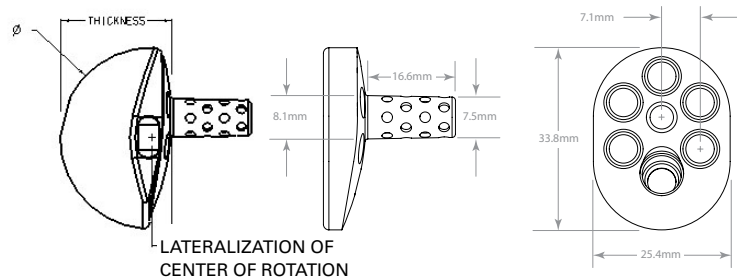

These products are manufactured by Exactech, Inc. and distributed by Advita Ortho, LLC.

For additional device information, refer to the manufacturer's Instructions for Use for information including, but not limited to, a device description, indications, contraindications, precautions and warnings. For further product information, please contact Customer Service, Advita Ortho, LLC 2320 NW 66th Court, Gainesville, Florida 32653-1630, USA. (833) 4-ADVITA.

Exactech, as the manufacturer of this device, does not practice medicine and is not responsible for recommending the appropriate surgical technique for use on a particular patient. Because this information does not purport to constitute any diagnostic or therapeutic statement with regard to any individual medical case, each patient must be examined and advised individually, and this document does not replace the need for such examination and/or advice in whole or in part. These guidelines are intended to be solely informational, and each surgeon must evaluate the appropriateness of these guidelines based on his or her personal medical training and experience. Prior to use of this system, the surgeon should refer to the product package insert for information including, but not limited to, comprehensive warnings, precautions, indications for use, contraindications and adverse effects.

The products discussed herein may be available under different trademarks in different countries. All copyrights, and pending and registered trademarks, are property of Advita Ortho, LLC. **This material is intended for the sole use and benefit of the Advita Ortho sales force and physicians; it is not intended for laypersons.** It should not be redistributed, duplicated or disclosed without the express written consent of Advita Ortho, LLC. ©2025 Advita Ortho, LLC. OPTECH-000161/A 102325



GLOBAL HEADQUARTERS
2320 NW 66TH COURT
GAINESVILLE, FL 32653-1630 USA
(833) 4-ADVITA
advita.com